

## Type 5K, End Code 12

Call 800-321-7800 or visit us online at [www.nookindustries.com](http://www.nookindustries.com) to configure and order your Type 5K, End Code 12 today!

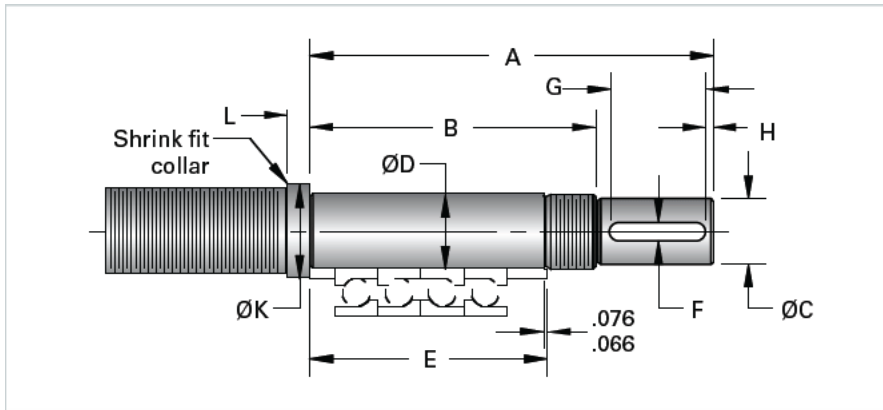

### Product Info

Nominal Bearing Journal Size [mm]

12

### Dimensions

A [mm]

117

B [mm]

85

C Maximum [mm]

10

C Minimum [mm]

9.97

D Maximum [mm]

12.008

D Minimum [mm]

11.997

E [mm]

69

F [mm]

3

G [mm]

26

H [mm]

2

K [mm]

18

L [mm]

8

Lock Nut

SFZ 12X1