

EZZE-MOUNT EZM-4045

Call 800-321-7800 or visit us online at www.nookindustries.com to configure and order your EZZE-MOUNT EZM-4045 today!

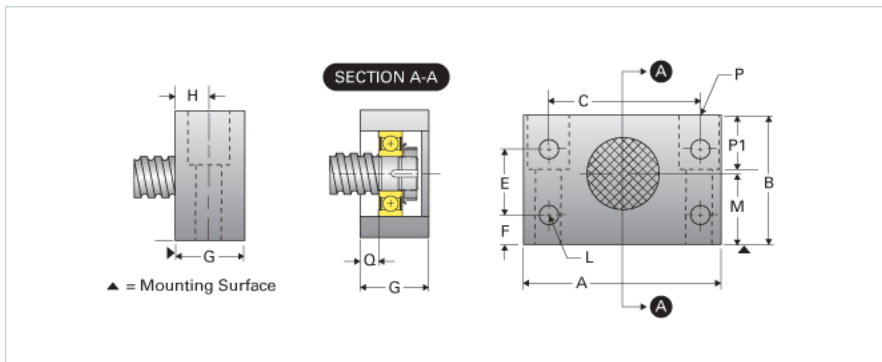
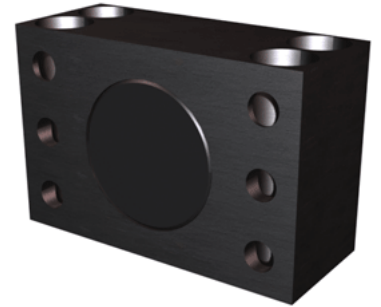

Product Info

| | |
|-----------------------------------|----------|
| Part Number | EZM-4045 |
| Machined End Code | 45 |
| Nominal Bearing Journal Size [mm] | 45 |

Dimensions

| | |
|---------------------------|----------|
| A [in] | 8.50 |
| B [in] | 5.62 |
| C [in] | 6.62 |
| E [in] | 1.81 |
| F [in] | 1.00 |
| G [in] | 3.47 |
| H [in] | 0.88 |
| L Holes [Number of Holes] | 6 |
| L Thru [in] | 0.81 |
| M [in] | 2.812 |
| P C Bore [in] | 1.56 |
| P P1 [in] | 2.13 |
| Q [in] | 0.98 |
| P - Bolt Size (2 or 4) | 1 x 5(4) |
| P-Thru [in] | 1.03 |

Weight

| | |
|-------------|-------|
| Weight [lb] | 29.00 |
|-------------|-------|