

## EZZE-MOUNT EZM-4020

Call 800-321-7800 or visit us online at [www.nookindustries.com](http://www.nookindustries.com) to configure and order your EZZE-MOUNT EZM-4020 today!

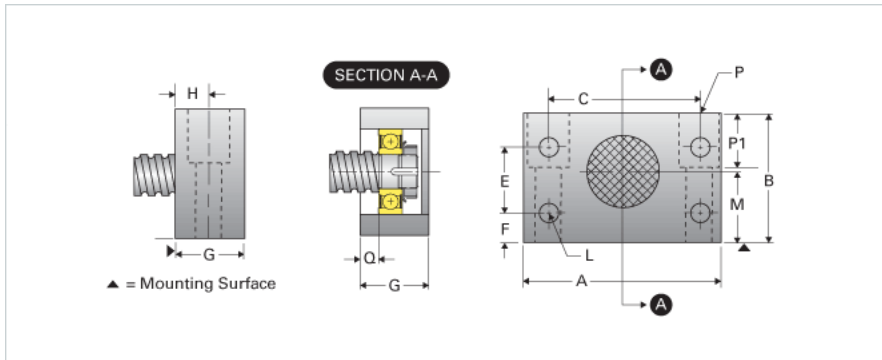

### Product Info

|                                   |          |
|-----------------------------------|----------|
| Part Number                       | EZM-4020 |
| Machined End Code                 | 20       |
| Nominal Bearing Journal Size [mm] | 20       |

### Dimensions

|                           |               |
|---------------------------|---------------|
| A [in]                    | 5.00          |
| B [in]                    | 3.03          |
| C [in]                    | 3.75          |
| E [in]                    | 1.50          |
| F [in]                    | 0.75          |
| G [in]                    | 1.72          |
| H [in]                    | 0.86          |
| L Holes [Number of Holes] | 4             |
| L Thru [in]               | 0.47          |
| M [in]                    | 1.625         |
| P C'Bore [in]             | 1.00          |
| P P1 [in]                 | 1.50          |
| Q [in]                    | 0.55          |
| P - Bolt Size (2 or 4)    | 5/8 x2 1/2(2) |
| P-Thru [in]               | 0.66          |

### Weight

|             |      |
|-------------|------|
| Weight [lb] | 5.00 |
|-------------|------|