

EZZE-MOUNT EZM-4017

Call 800-321-7800 or visit us online at www.nookindustries.com to configure and order your EZZE-MOUNT EZM-4017 today!

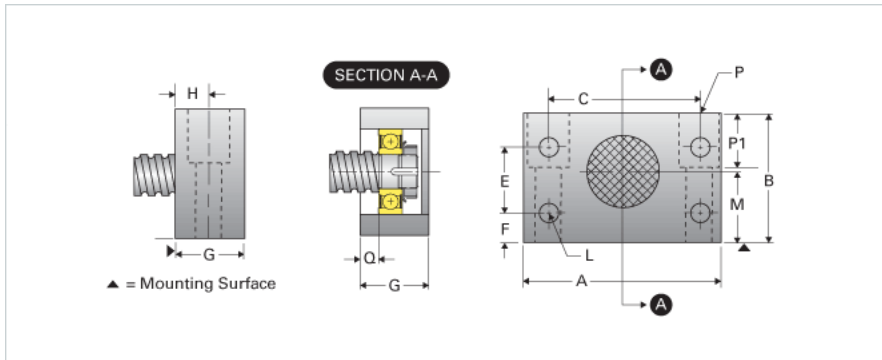

Product Info

Part Number	EZM-4017
Machined End Code	17
Nominal Bearing Journal Size [mm]	17

Dimensions

A [in]	4.50
B [in]	2.69
C [in]	3.38
E [in]	1.38
F [in]	0.62
G [in]	1.69
H [in]	0.84
L Holes [Number of Holes]	4
L Thru [in]	0.41
M [in]	1.500
P C'Bore [in]	0.88
P P1 [in]	1.25
Q [in]	0.38
P - Bolt Size (2 or 4)	1/2 x2 1/4(2)
P-Thru [in]	0.53

Weight

Weight [lb]	3.90
-------------	------