

EZZE-MOUNT EZM-4009

Call 800-321-7800 or visit us online at www.nookindustries.com to configure and order your EZZE-MOUNT EZM-4009 today!

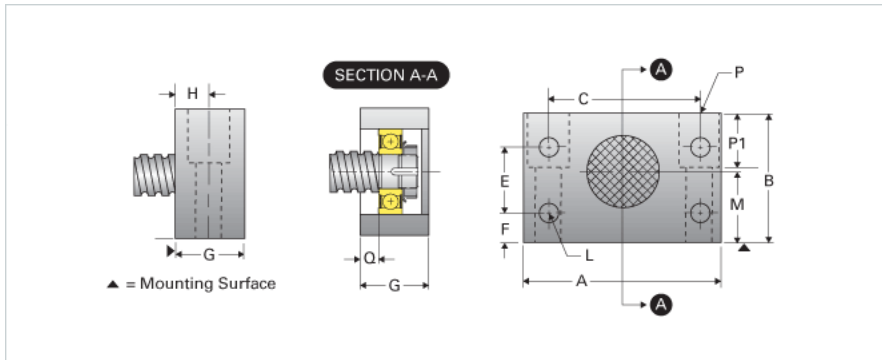
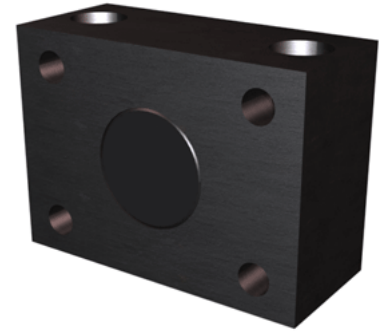

Product Info

Part Number	EZM-4009
Machined End Code	9
Nominal Bearing Journal Size [mm]	9

Dimensions

A [in]	2.75
B [in]	2.00
C [in]	2.00
E [in]	1.38
F [in]	0.31
G [in]	1.19
H [in]	0.56
L Holes [Number of Holes]	4
L Thru [in]	0.28
M [in]	1.000
P C Bore [in]	0.50
P P1 [in]	0.56
Q [in]	0.38
P - Bolt Size (2 or 4)	5/16 x2(2)
P-Thru [in]	0.34

Weight

Weight [lb]	1.40
-------------	------