

EZZE-MOUNT EZM-4008

Call 800-321-7800 or visit us online at www.nookindustries.com to configure and order your EZZE-MOUNT EZM-4008 today!

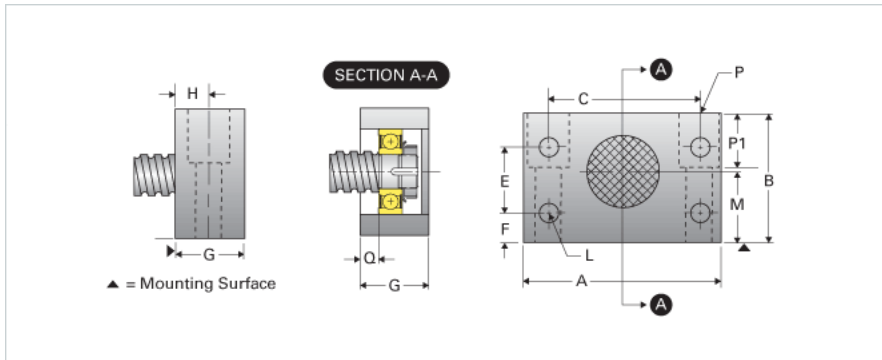
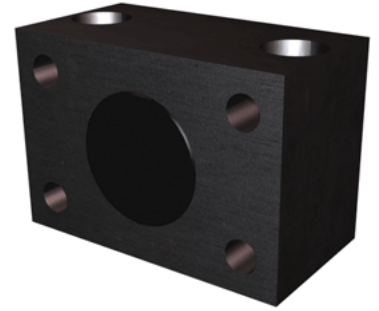

Product Info

Part Number	EZM-4008
Machined End Code	8
Nominal Bearing Journal Size [mm]	8

Dimensions

A [in]	2.00
B [in]	1.38
C [in]	1.50
E [in]	0.88
F [in]	0.25
G [in]	1.06
H [in]	0.50
L Holes [Number of Holes]	4
L Thru [in]	0.22
M [in]	0.687
P C'Bore [in]	0.41
P P1 [in]	0.41
Q [in]	0.19
P - Bolt Size (2 or 4)	1/4 x1 3/8(2)
P-Thru [in]	0.28

Weight

Weight [lb]	0.50
-------------	------