

EZZE-MOUNT EZM-1009

Call 800-321-7800 or visit us online at www.nookindustries.com to configure and order your EZZE-MOUNT EZM-1009 today!

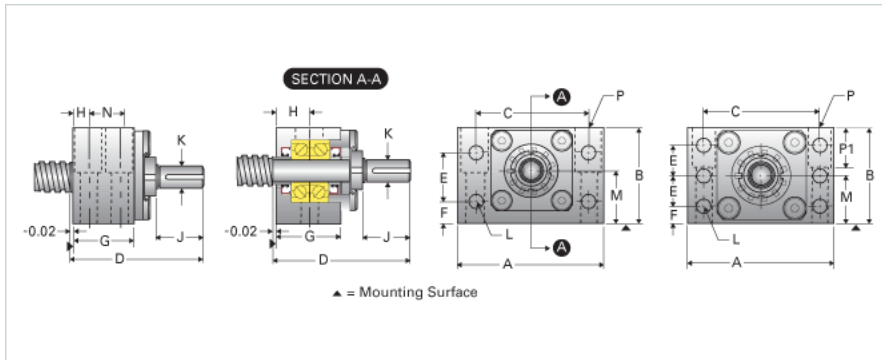
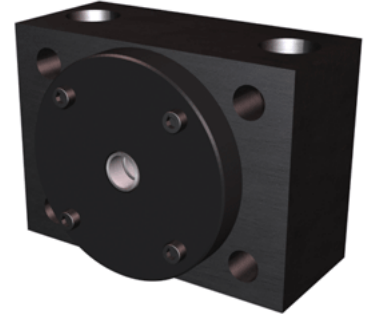

Product Info

Part Number	EZM-1009
Machined End Code	9
Nominal Bearing Journal Size [mm]	9

Dimensions

A [in]	2.75
B [in]	2.00
C [in]	2.00
D [in]	2.38
E [in]	1.38
F [in]	0.31
G [in]	1.19
H [in]	0.56
J [in]	0.56
K Shaft Diameter Maximum [in]	0.250
K Shaft Diameter Minimum [in]	0.249
L Holes [Number of Holes]	4
L Thru [in]	0.28
M [in]	1.000
N [in]	-
P C'Bore [in]	0.50
P P1 [in]	0.56
Q [in]	0.38
P - Bolt Size (2 or 4)	5/16 x2(2)
P-Thru [in]	0.34

Weight

Weight [lb]	1.76
-------------	------