

## EZZE-MOUNT EZM-1008

Call 800-321-7800 or visit us online at [www.nookindustries.com](http://www.nookindustries.com) to configure and order your EZZE-MOUNT EZM-1008 today!

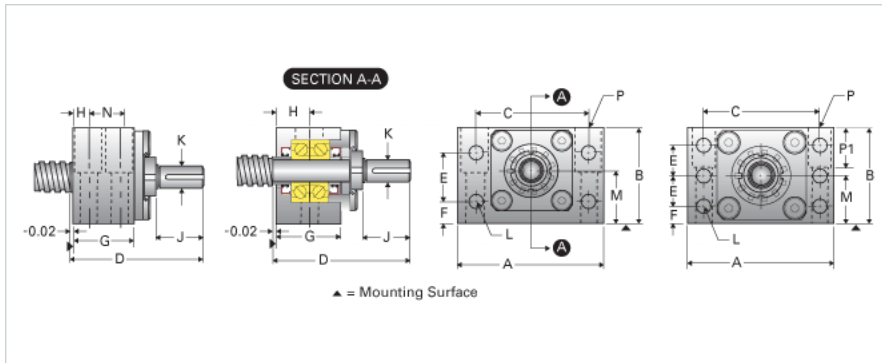
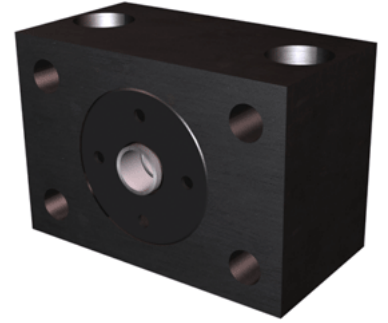

### Product Info

Part Number	EZM-1008
Machined End Code	8
Nominal Bearing Journal Size [mm]	8

### Dimensions

A [in]	2.00
B [in]	1.38
C [in]	1.50
D [in]	2.00
E [in]	0.88
F [in]	0.25
G [in]	1.06
H [in]	0.50
J [in]	0.56
K Shaft Diameter Maximum [in]	0.250
K Shaft Diameter Minimum [in]	0.249
L Holes [Number of Holes]	4
L Thru [in]	0.22
M [in]	0.687
N [in]	-
P C Bore [in]	0.41
P P1 [in]	0.41
Q [in]	0.19
P - Bolt Size (2 or 4)	1/4 x 1 3/8(2)
P-Thru [in]	0.28

### Weight

Weight [lb]	0.66
-------------	------