

EZZE-MOUNT EZM-3025-34

Call 800-321-7800 or visit us online at www.nookindustries.com to configure and order your EZZE-MOUNT EZM-3025-34 today!

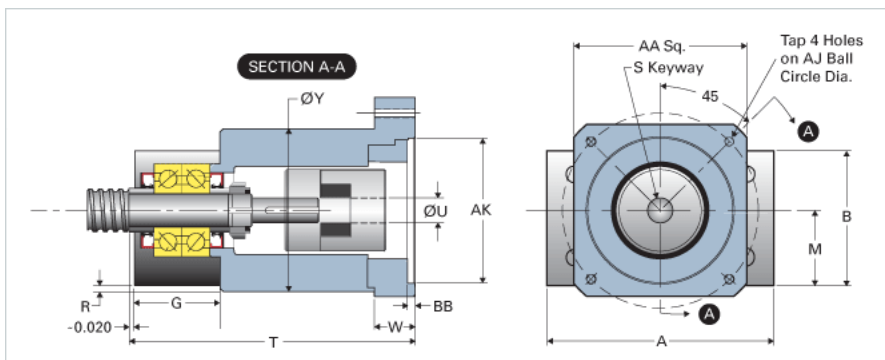
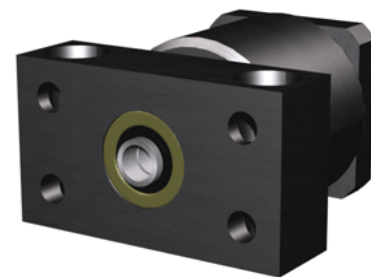

Product Info

Part Number	EZM-3025-34
Reference Code	U3
Machined End Code	25
Nema Frame Reference	34
Nominal Bearing Journal Size [mm]	25

Dimensions

A [in]	6.50
AA [in]	4.00
AJ [in]	3.875
AK Maximum [in]	2.882
AK Minimum [in]	2.878
B [in]	3.69
BB [in]	0.16
[in]	4.75
D [in]	4.45
E [in]	2.00
F [in]	0.88
G [in]	1.94
H [in]	0.97
J [in]	1.61
K Shaft Diameter Maximum [in]	0.750
K Shaft Diameter Minimum [in]	0.749
L Holes [Number of Holes]	4
L Thru [in]	0.660
M [in]	1.875
N	-
Q [in]	0.52
R [in]	0.31
S [in]	0.125
T [in]	6.44
U [in]	0.50
W [in]	0.81
Y [in]	4.38
P - Bolt Count	2
P - Bolt Size	7/8 x 3 1/4
P - C'Bore [in]	1.38
P - P1 [in]	1.75
P - Thru [in]	0.91
TAP	#10-32