

EZZE-MOUNT EZM-2020-34

Call 800-321-7800 or visit us online at www.nookindustries.com to configure and order your EZZE-MOUNT EZM-2020-34 today!

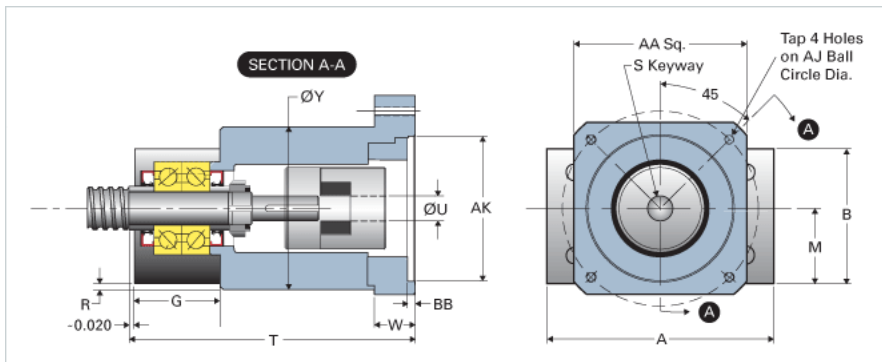
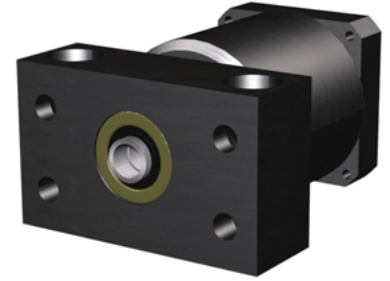

Product Info

Part Number	EZM-2020-34
Reference Code	U3
Machined End Code	20
Nema Frame Reference	34
Nominal Bearing Journal Size [mm]	20

Dimensions

A [in]	5.00
AA [in]	3.44
AJ [in]	3.875
AK Maximum [in]	2.882
AK Minimum [in]	2.878
B [in]	3.03
BB [in]	0.16
[in]	3.75
D [in]	4.03
E [in]	1.50
F [in]	0.75
G [in]	1.72
H [in]	0.86
J [in]	1.30
K Shaft Diameter Maximum [in]	0.625
K Shaft Diameter Minimum [in]	0.624
L Holes [Number of Holes]	4
L Thru [in]	0.470
M [in]	1.625
N	-
Q [in]	0.55
R [in]	0.10
S [in]	0.125
T [in]	5.96
U [in]	0.50
W [in]	0.81
Y [in]	3.44
P - Bolt Count	2
P - Bolt Size	5/8 x 2 1/2
P - C'Bore [in]	1.00
P - P1 [in]	1.50
P - Thru [in]	0.66
TAP	#10-32