

## EZZE-MOUNT EZF-4030

Call 800-321-7800 or visit us online at [www.nookindustries.com](http://www.nookindustries.com) to configure and order your EZZE-MOUNT EZF-4030 today!

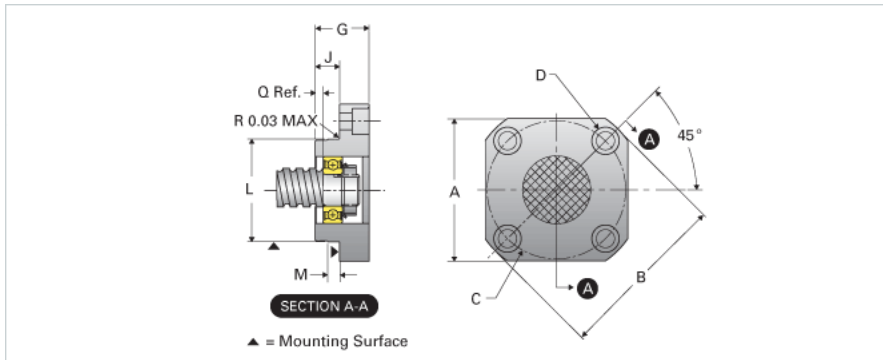
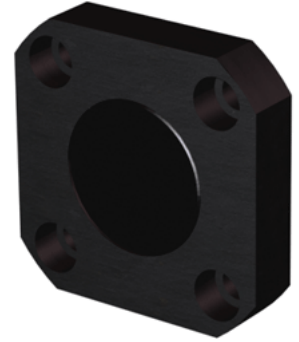

### Product Info

Part Number	EZF-4030
Machined End Code	30
Nominal Bearing Journal Size [mm]	30

### Dimensions

A [in]	4.38
B - Diameter [in]	5.31
C Bolt Circle [in]	4.250
C Bore [in]	0.81
D Thru [in]	0.531
G [in]	1.67
J [in]	0.76
L Maximum [in]	3.1492
L Minimum [in]	3.1482
M [in]	0.375
Q [in]	0.25

### Weight

Weight [lb]	5.33
-------------	------