

EZFE-MOUNT EZF-4020

Call 800-321-7800 or visit us online at www.nookindustries.com to configure and order your EZFE-MOUNT EZF-4020 today!

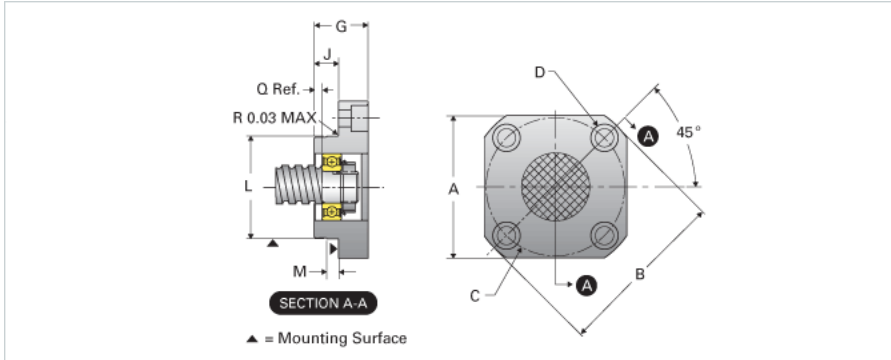
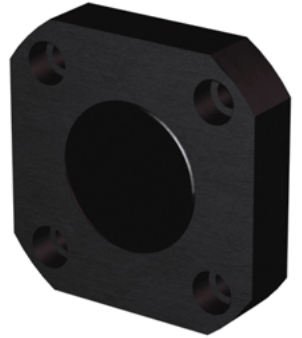

Product Info

Part Number	EZF-4020
Machined End Code	20
Nominal Bearing Journal Size [mm]	20

Dimensions

A [in]	3.38
B - Diameter [in]	4.03
C Bolt Circle [in]	3.250
C Bore [in]	0.53
D Thru [in]	0.344
G [in]	1.47
J [in]	0.72
L Maximum [in]	2.5193
L Minimum [in]	2.5185
M [in]	0.312
Q [in]	0.20

Weight

Weight [lb]	2.93
-------------	------