

## EZFE-MOUNT EZF-4015

Call 800-321-7800 or visit us online at [www.nookindustries.com](http://www.nookindustries.com) to configure and order your EZFE-MOUNT EZF-4015 today!

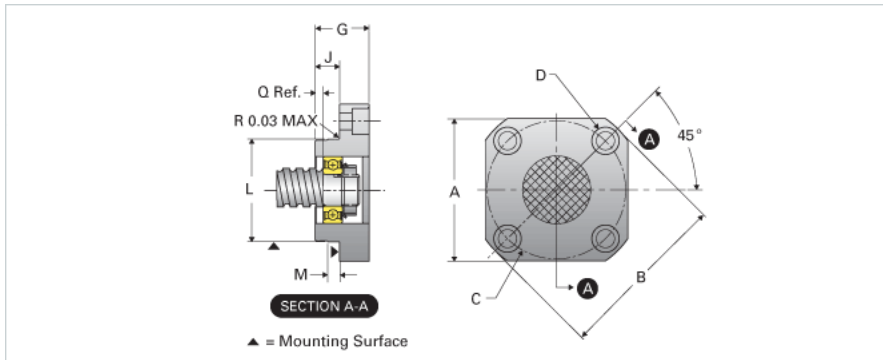
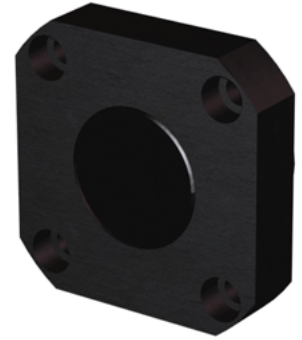

### Product Info

Part Number	EZF-4015
Machined End Code	15
Nominal Bearing Journal Size [mm]	15

### Dimensions

A [in]	2.70
B - Diameter [in]	3.27
C Bolt Circle [in]	2.750
C Bore [in]	0.44
D Thru [in]	0.281
G [in]	1.25
J [in]	0.63
L Maximum [in]	2.1256
L Minimum [in]	2.1250
M [in]	0.312
Q [in]	0.20

### Weight

Weight [lb]	1.60
-------------	------