

EZZE-MOUNT EZF-3025

Call 800-321-7800 or visit us online at www.nookindustries.com to configure and order your EZZE-MOUNT EZF-3025 today!

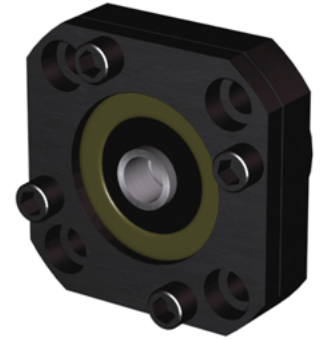
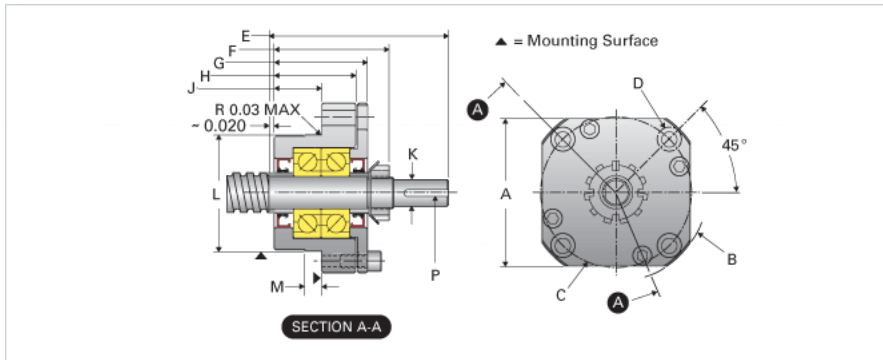

Product Info

Part Number	EZF-3025
Machined End Code	25
Nominal Bearing Journal Size [mm]	25

Dimensions

A [in]	4.38
B - Diameter [in]	5.31
C Bolt Circle [in]	4.25
C Bore [in]	0.81
D Thru [in]	0.531
E [in]	4.45
F [in]	2.89
G [in]	2.36
H [in]	1.94
J [in]	1.19
K Shaft Diameter Maximum [in]	0.750
K Shaft Diameter Minimum [in]	0.749
L Minimum [in]	3.1482
L Maximum [in]	3.1492
M [in]	0.375
P [in]	0.188
Q [in]	0.25

Weight

Weight [lb]	6.68
-------------	------