

EZZE-MOUNT EZF-3015-23

Call 800-321-7800 or visit us online at www.nookindustries.com to configure and order your EZZE-MOUNT EZF-3015-23 today!

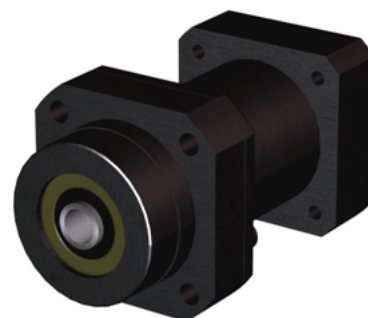

Product Info

| | |
|-----------------------------------|-------------|
| Part Number | EZF-3015-23 |
| Reference Code | Y2 |
| Machined End Code | 15 |
| Nema Frame Reference | 23 |
| Nominal Bearing Journal Size [mm] | 15 |

Dimensions

| | |
|-------------------------------|--------|
| A [in] | 2.70 |
| AA [in] | 2.50 |
| AJ [in] | 2.625 |
| AK Maximum [in] | 1.506 |
| AK Minimum [in] | 1.503 |
| B - Diameter [in] | 3.27 |
| BB [in] | 0.19 |
| C Bolt Circle [in] | 2.75 |
| C'Bore [in] | 0.44 |
| D Thru [in] | 0.281 |
| E [in] | 3.50 |
| F [in] | 2.10 |
| G [in] | 1.71 |
| H [in] | 1.50 |
| J [in] | 0.88 |
| K Shaft Diameter Maximum [in] | 0.500 |
| K Shaft Diameter Minimum [in] | 0.499 |
| L Maximum [in] | 2.1250 |
| L Minimum [in] | 2.1256 |
| M [in] | 0.312 |
| P [in] | 0.125 |
| Q [in] | 0.20 |
| S [in] | 0.125 |
| T [in] | 3.84 |
| U [in] | 0.38 |
| W [in] | 0.88 |
| Y [in] | 1.98 |
| TAP | #10-32 |