

EZZE-MOUNT EZF-1009-23

Call 800-321-7800 or visit us online at www.nookindustries.com to configure and order your EZZE-MOUNT EZF-1009-23 today!

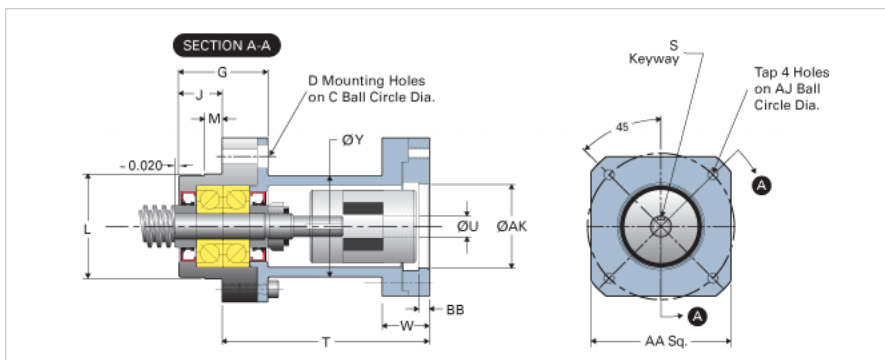
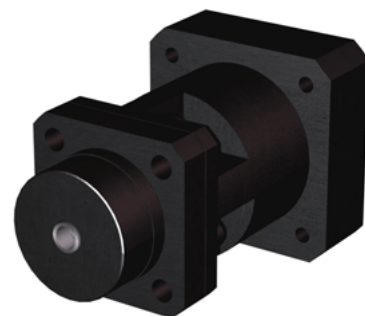

Product Info

Part Number	EZF-1009-23
Reference Code	Y2
Machined End Code	9
Nema Frame Reference	23
Nominal Bearing Journal Size [mm]	9

Dimensions

A [in]	2.00
AA [in]	2.50
AJ [in]	2.625
AK Maximum [in]	1.506
AK Minimum [in]	1.503
B - Diameter [in]	2.60
BB [in]	0.19
C Bolt Circle [in]	2.00
C'Bore [in]	0.44
D Thru [in]	0.266
E [in]	2.38
F [in]	1.81
G [in]	1.33
H [in]	1.09
J [in]	0.71
K Shaft Diameter Maximum [in]	0.250
K Shaft Diameter Minimum [in]	0.249
L Maximum [in]	1.4951
L Minimum [in]	1.4957
M [in]	0.188
P [in]	0.094
Q [in]	0.13
S [in]	0.125
T [in]	3.41
U [in]	0.38
W [in]	0.88
Y [in]	2.10
TAP	#10-32