

## ActionJac 25SS-MSJ-IR 32:1

Call 800-321-7800 or visit us online at [www.nookindustries.com](http://www.nookindustries.com) to configure and order your ActionJac 25SS-MSJ-IR 32:1 today!

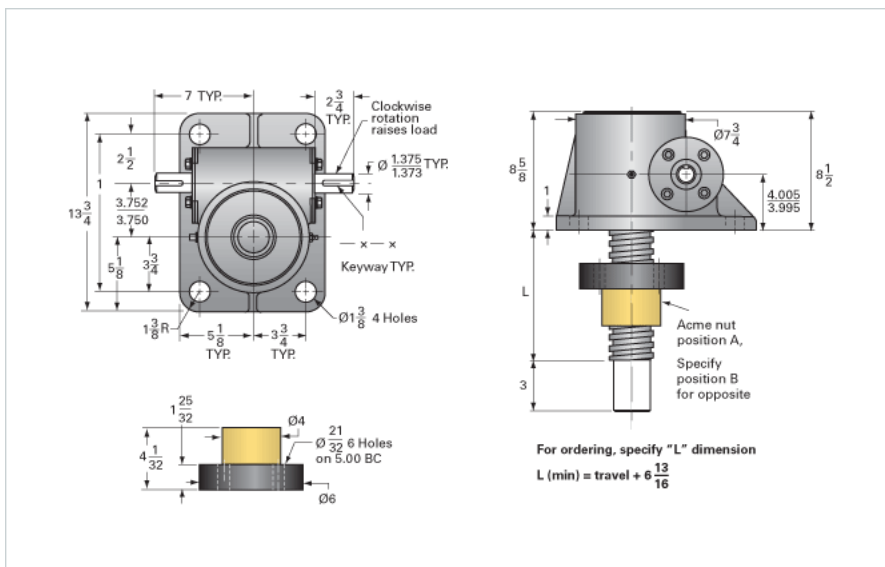

### Details

Capacity [Ton]	8.30
Gear Ratio	32:1
Turns of Worm per Inch Travel	48
Torque to Raise 1 lb. [in-lb]	0.0235
Lifting Screw Diameter [in]	3.00
Screw Lead [in]	0.667
Root Diameter [in]	2.287
Tare Drag Torque [in-lb]	50

### Performance Specifications

Maximum Allowable Input [hp]	3.50
Maximum Input Torque [in-lb]	471
Maximum Load at 1750 RPM	5364
Starting Torque	2 x Running Torque

### Weight

Base 0 Travel [lb]	155
Per Inch of Travel [lb]	3.10
Grease [lb]	3.5