

## ActionJac 15SS-MSJ-IR 8:1

Call 800-321-7800 or visit us online at [www.nookindustries.com](http://www.nookindustries.com) to configure and order your ActionJac 15SS-MSJ-IR 8:1 today!

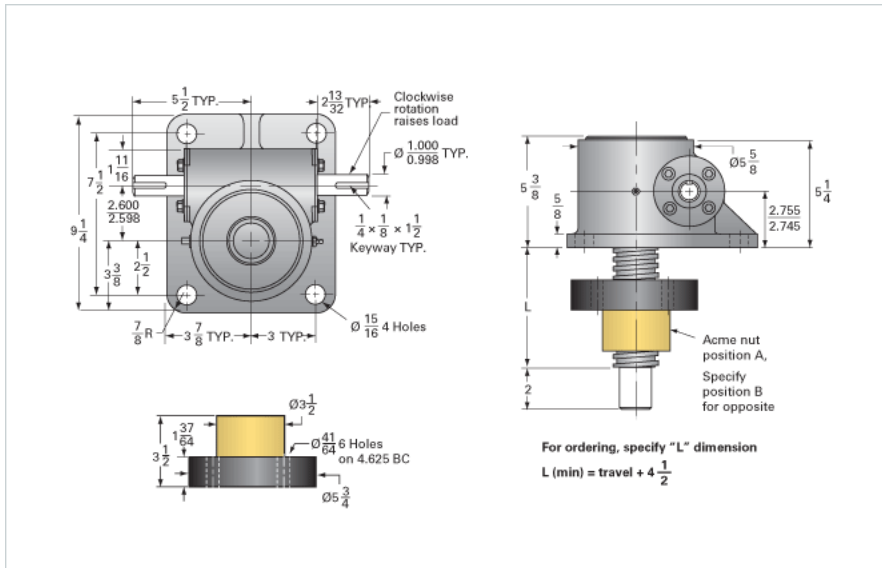
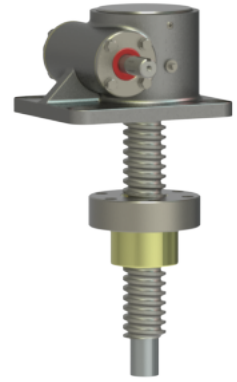

### Details

Capacity [Ton]	5.00
Gear Ratio	8:1
Turns of Worm per Inch Travel	16
Torque to Raise 1 lb. [in-lb]	0.0407
Lifting Screw Diameter [in]	2.25
Screw Lead [in]	0.500
Root Diameter [in]	1.684
Tare Drag Torque [in-lb]	20

### Performance Specifications

Maximum Allowable Input [hp]	5.00
Maximum Input Torque [in-lb]	407
Maximum Load at 1750 RPM	4424
Starting Torque	2 x Running Torque

### Weight

Base 0 Travel [lb]	60
Per Inch of Travel [lb]	1.40
Grease [lb]	1.5