

## ActionJac EM5-MSJ-U 6:1

Call 800-321-7800 or visit us online at [www.nookindustries.com](http://www.nookindustries.com) to configure and order your ActionJac EM5-MSJ-U 6:1 today!

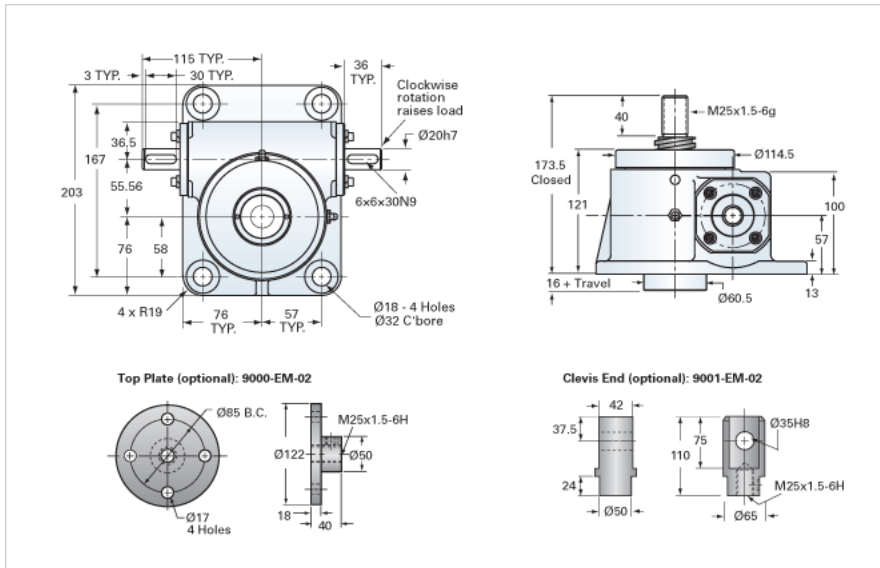

### Details

Capacity [kN]	50
Gear Ratio	6:1
Raise for One Turn of Worm [mm]	1.17
Torque to Raise 1 kN [Nm]	0.81
No Load Torque [Nm]	1.13
Lifting Screw Diameter [mm]	40
Screw Lead [mm]	7
Root Diameter [mm]	30.9

### Performance Specifications

Maximum Allowable Input [kW]	1.87
Maximum Input Torque [Nm]	40.30
Maximum Load at 1425 RPM [kN]	15.6
Maximum Worm Speed at Rated Load [rpm]	445
Starting Torque	2 x Running Torque

### Weight

Base 0 Travel [kg]	13.60
Per 100mm of Travel [kg]	0.81
Grease [kg]	0.45