

## ActionJac EM2.5-MSJ-U 6:1

Call 800-321-7800 or visit us online at [www.nookindustries.com](http://www.nookindustries.com) to configure and order your ActionJac EM2.5-MSJ-U 6:1 today!

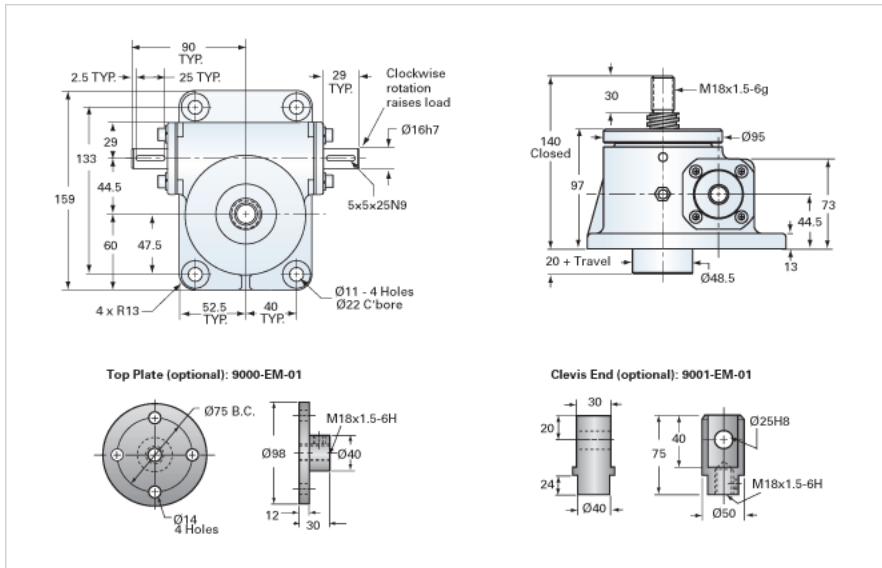

### Details

Capacity [kN]	25
Gear Ratio	6:1
Raise for One Turn of Worm [mm]	1.00
Torque to Raise 1 kN [Nm]	0.59
No Load Torque [Nm]	0.56
Lifting Screw Diameter [mm]	26
Screw Lead [mm]	6
Root Diameter [mm]	17.8

### Performance Specifications

Maximum Allowable Input [kW]	1.51
Maximum Input Torque [Nm]	14.90
Maximum Load at 1425 RPM [kN]	17.0
Maximum Worm Speed at Rated Load [rpm]	975
Starting Torque	2 x Running Torque

### Weight

Base 0 Travel [kg]	7.70
Per 100mm of Travel [kg]	0.32
Grease [kg]	0.22