

ActionJac EM20-MSJ-UR 8:1

Call 800-321-7800 or visit us online at www.nookindustries.com to configure and order your ActionJac EM20-MSJ-UR 8:1 today!

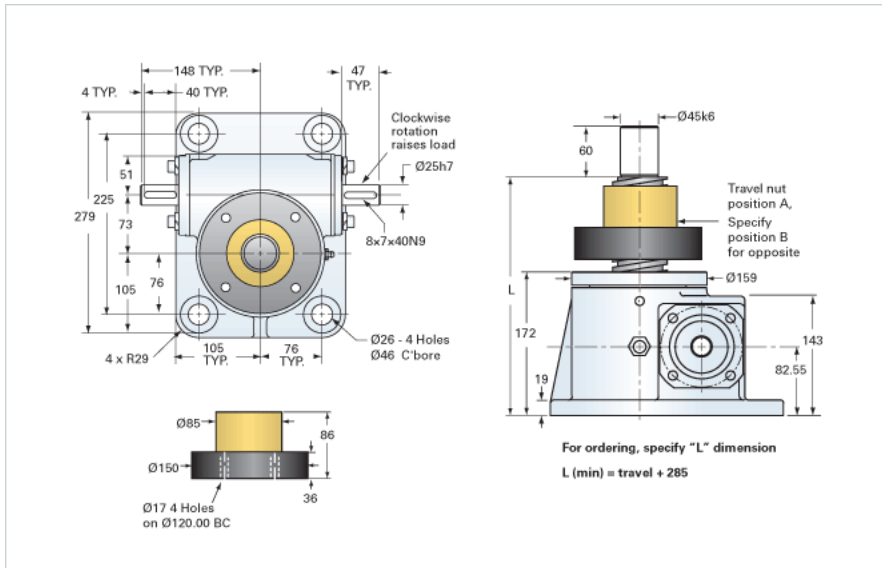

Details

Capacity [kN]	200
Gear Ratio	8:1
Raise for One Turn of Worm [mm]	1.50
Torque to Raise 1 kN [Nm]	1.08
No Load Torque [Nm]	4.52
Lifting Screw Diameter [mm]	65
Screw Lead [mm]	12
Root Diameter [mm]	50.0

Performance Specifications

Maximum Allowable Input [kW]	5.60
Maximum Input Torque [Nm]	215.00
Maximum Load at 1425 RPM [kN]	35.0
Maximum Worm Speed at Rated Load [rpm]	250
Starting Torque	2 x Running Torque

Weight

Base 0 Travel [kg]	36.30
Per 100mm of Travel [kg]	2.12
Grease [kg]	1.00