

## ActionJac EM5-MSJ-IR 24:1

Call 800-321-7800 or visit us online at [www.nookindustries.com](http://www.nookindustries.com) to configure and order your ActionJac EM5-MSJ-IR 24:1 today!

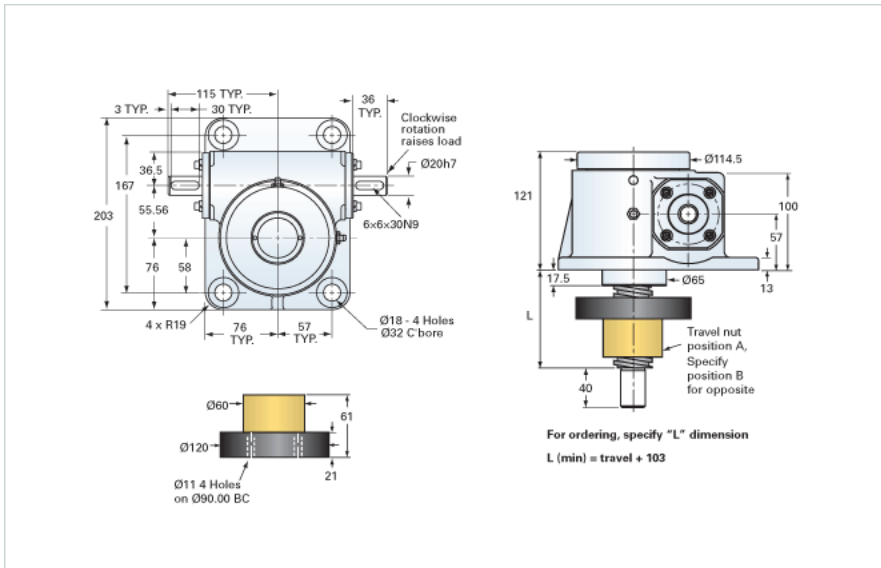

### Details

|                                |      |
|--------------------------------|------|
| Capacity [kN]                  | 50   |
| Gear Ratio                     | 24:1 |
| Travel for 1 Turn of Worm [mm] | 0.29 |
| Torque to Raise 1 kN [Nm]      | 0.32 |
| No Load Torque [Nm]            | 1.13 |
| Lifting Screw Diameter [mm]    | 40   |
| Screw Lead [mm]                | 7    |
| Root Diameter [mm]             | 30.9 |

### Performance Specifications

|  |                    |
|--|--------------------|
| Maximum Allowable Input [kW]           | 0.51               |
| Maximum Input Torque [Nm]              | 16.00              |
| Maximum Load at 1425 RPM [kN]          | 10.7               |
| Maximum Worm Speed at Rated Load [rpm] | 300                |
| Starting Torque                        | 2 x Running Torque |

### Weight

|                          |       |
|--------------------------|-------|
| Base 0 Travel [kg]       | 13.60 |
| Per 100mm of Travel [kg] | 0.81  |
| Grease [kg]              | 0.45  |