

ActionJac EM05-MSJ-IR 20:1

Call 800-321-7800 or visit us online at www.nookindustries.com to configure and order your ActionJac EM05-MSJ-IR 20:1 today!

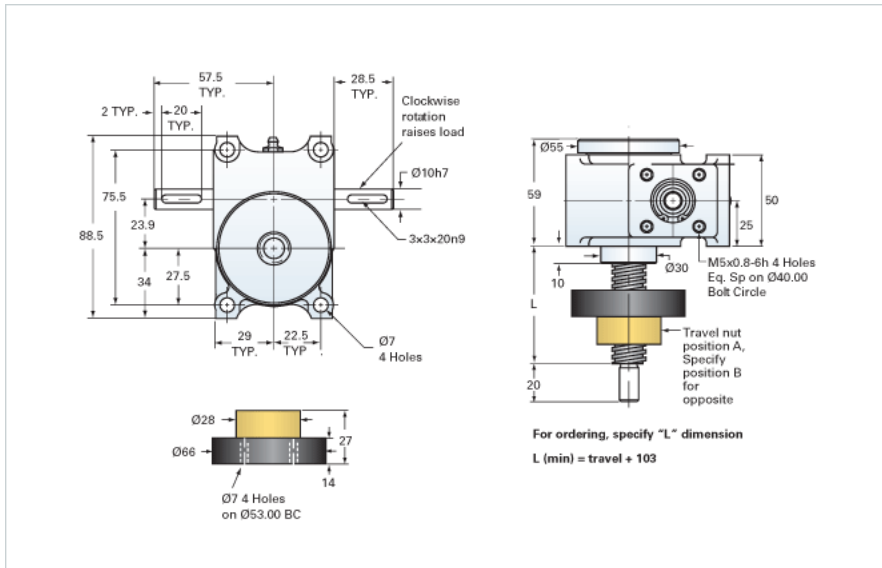

Details

Capacity [kN]	5
Gear Ratio	20:1
Travel for 1 Turn of Worm [mm]	0.2
Torque to Raise 1 kN [Nm]	0.19
No Load Torque [Nm]	0.11
Lifting Screw Diameter [mm]	16
Screw Lead [mm]	4
Root Diameter [mm]	10.9

Performance Specifications

Maximum Allowable Input [kW]	0.13
Maximum Input Torque [Nm]	0.94
Maximum Load at 1425 RPM [kN]	4.6
Maximum Worm Speed at Rated Load [rpm]	1130
Starting Torque	2 x Running Torque

Weight

Base 0 Travel [kg]	1.13
Per 100mm of Travel [kg]	0.12
Grease [kg]	0.23