

ActionJac EM2.5-BSJ-U 24:1

Call 800-321-7800 or visit us online at www.nookindustries.com to configure and order your ActionJac EM2.5-BSJ-U 24:1 today!

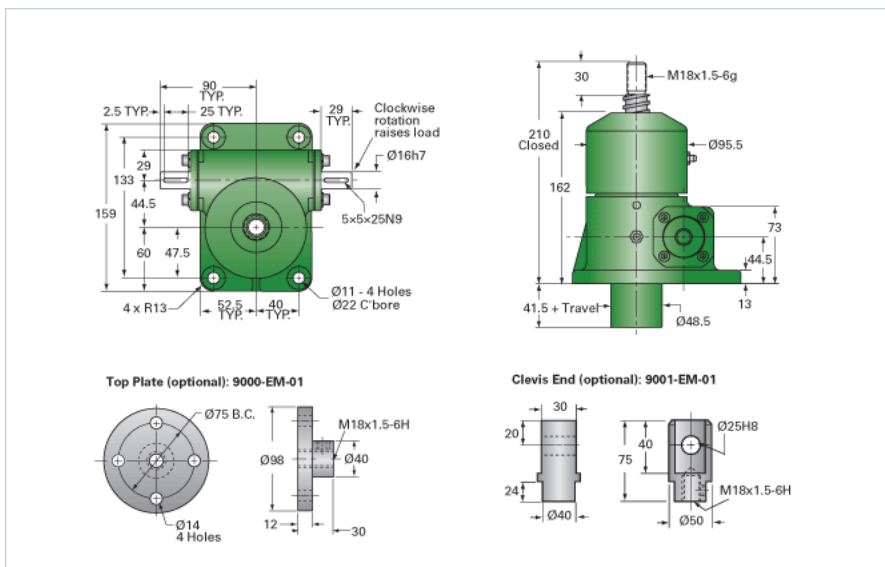

Details

Capacity [kN]	25
Gear Ratio	24:1
Raise for One Turn of Worm [mm]	0.21
Torque to Raise 1 kN [Nm]	0.09
No Load Torque [Nm]	0.56
Lifting Screw Diameter [mm]	25
Screw Lead [mm]	5
Root Diameter [mm]	22.5
BackDrive Holding Torque [Nm]	2.0

Performance Specifications

Maximum Allowable Input [kW]	0.38
Maximum Input Torque [Nm]	2.13
Maximum Load at 1425 RPM [kN]	25
Maximum Worm Speed at Rated Load [rpm]	1695
Starting Torque	1.5 x Running Torque

Weight

Base 0 Travel [kg]	7.70
Per 100mm of Travel [kg]	0.36
Grease [kg]	0.22