

## ActionJac EM10-BSJ-UR 8:1

Call 800-321-7800 or visit us online at [www.nookindustries.com](http://www.nookindustries.com) to configure and order your ActionJac EM10-BSJ-UR 8:1 today!

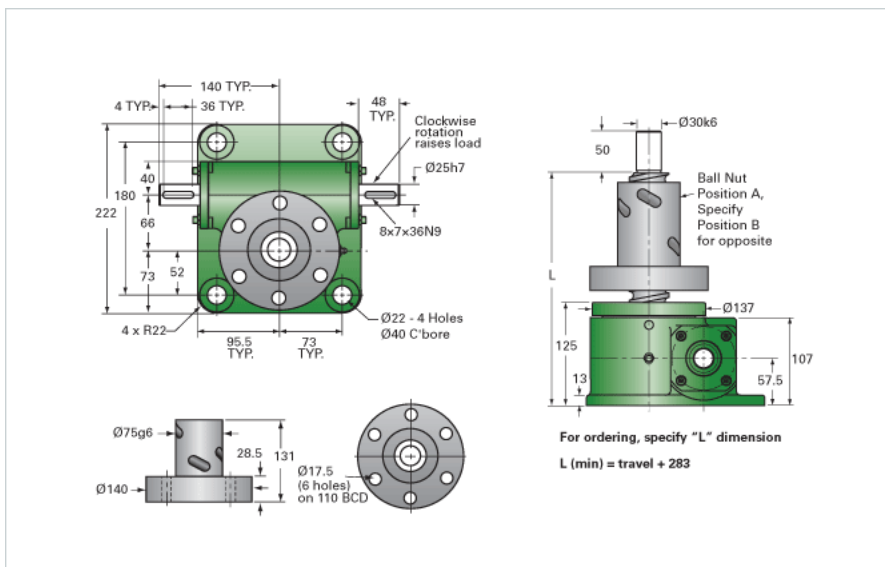

### Details

Capacity [kN]	100
Gear Ratio	8:1
Raise for One Turn of Worm [mm]	1.25
Torque to Raise 1 kN [Nm]	0.32
No Load Torque [Nm]	2.26
Lifting Screw Diameter [mm]	50
Screw Lead [mm]	10
Root Diameter [mm]	45.2
BackDrive Holding Torque [Nm]	26.0

### Performance Specifications

Maximum Allowable Input [kW]	3.75
Maximum Input Torque [Nm]	31.90
Maximum Load at 1425 RPM [kN]	78.9
Maximum Worm Speed at Rated Load [rpm]	1124
Starting Torque	1.5 x Running Torque

### Weight

Base 0 Travel [kg]	22.70
Per 100mm of Travel [kg]	1.46
Grease [kg]	0.68