

ActionJac EM2.5-BSJ-UR 6:1

Call 800-321-7800 or visit us online at www.nookindustries.com to configure and order your ActionJac EM2.5-BSJ-UR 6:1 today!

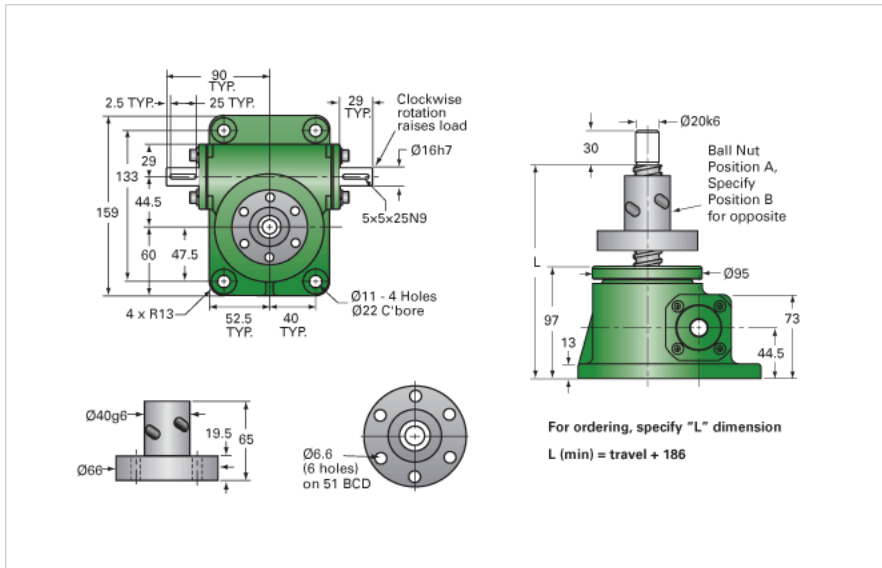

Details

| | |
|---------------------------------|------|
| Capacity [kN] | 25 |
| Gear Ratio | 6:1 |
| Raise for One Turn of Worm [mm] | 0.83 |
| Torque to Raise 1 kN [Nm] | 0.20 |
| No Load Torque [Nm] | 0.56 |
| Lifting Screw Diameter [mm] | 25 |
| Screw Lead [mm] | 5 |
| Root Diameter [mm] | 22.5 |
| BackDrive Holding Torque [Nm] | 4.5 |

Performance Specifications

| | |
|--|----------------------|
| Maximum Allowable Input [kW] | 1.08 |
| Maximum Input Torque [Nm] | 5.05 |
| Maximum Load at 1425 RPM [kN] | 25 |
| Maximum Worm Speed at Rated Load [rpm] | 2035 |
| Starting Torque | 1.5 x Running Torque |

Weight

| | |
|--------------------------|------|
| Base 0 Travel [kg] | 7.70 |
| Per 100mm of Travel [kg] | 0.36 |
| Grease [kg] | 0.22 |