

## ActionJac EM1-BSJ-I 5:1

Call 800-321-7800 or visit us online at [www.nookindustries.com](http://www.nookindustries.com) to configure and order your ActionJac EM1-BSJ-I 5:1 today!

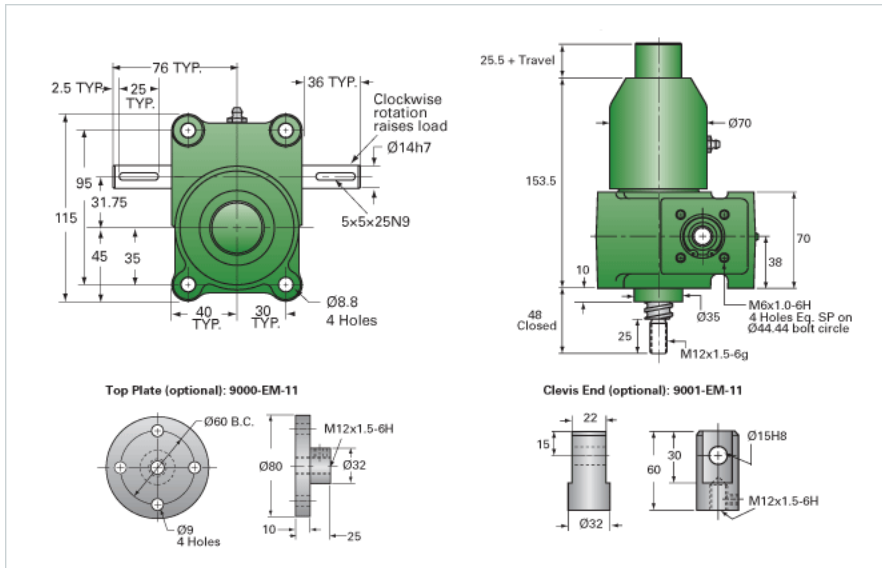

### Details

Capacity [kN]	10
Gear Ratio	5:1
Travel for 1 Turn of Worm [mm]	1.00
Torque to Raise 1 kN [Nm]	0.24
No Load Torque [Nm]	0.34
Lifting Screw Diameter [mm]	20
Screw Lead [mm]	5
Root Diameter [mm]	17.5
BackDrive Holding Torque [Nm]	2.0

### Performance Specifications

Maximum Allowable Input [kW]	0.38
Maximum Input Torque [Nm]	2.41
Maximum Load at 1425 RPM [kN]	10
Maximum Worm Speed at Rated Load [rpm]	1500
Starting Torque	1.5 x Running Torque

### Weight

Base 0 Travel [kg]	3.60
Per 100mm of Travel [kg]	0.23
Grease [kg]	0.23