

ActionJac EM05-BSJ-I 5:1

Call 800-321-7800 or visit us online at www.nookindustries.com to configure and order your ActionJac EM05-BSJ-I 5:1 today!

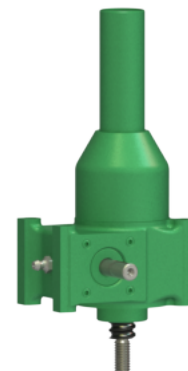
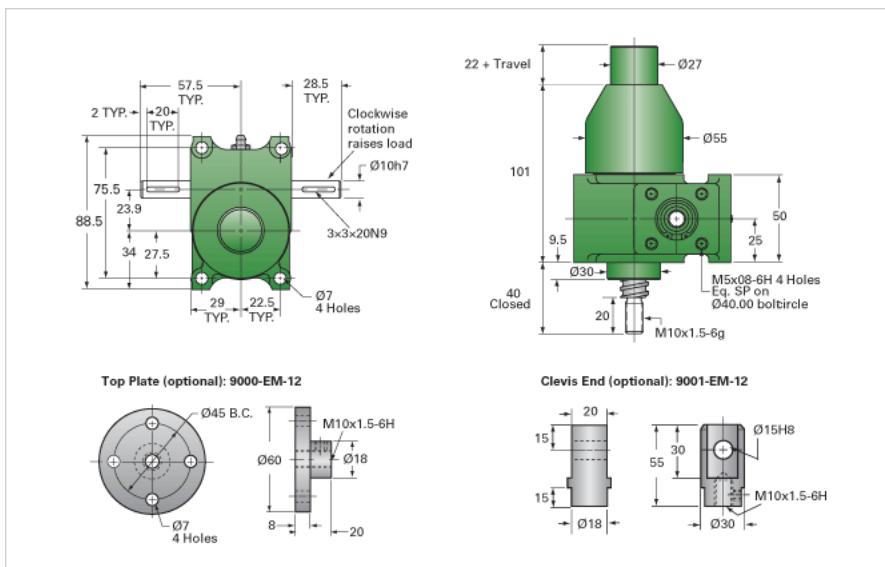

Details

Capacity [kN]	5
Gear Ratio	5:1
Travel for 1 Turn of Worm [mm]	1.00
Torque to Raise 1 kN [Nm]	0.24
No Load Torque [Nm]	0.11
Lifting Screw Diameter [mm]	15.7
Screw Lead [mm]	5
Root Diameter [mm]	12.9
BackDrive Holding Torque [Nm]	1.0

Performance Specifications

Maximum Allowable Input [kW]	0.12
Maximum Input Torque [Nm]	1.21
Maximum Load at 1425 RPM [kN]	5
Maximum Worm Speed at Rated Load [rpm]	1625
Starting Torque	1.5 x Running Torque

Weight

Base 0 Travel [kg]	1.36
Per 100mm of Travel [kg]	0.14
Grease [kg]	0.14