

ActionJac EM5-BSJ-IR 24:1

Call 800-321-7800 or visit us online at www.nookindustries.com to configure and order your ActionJac EM5-BSJ-IR 24:1 today!

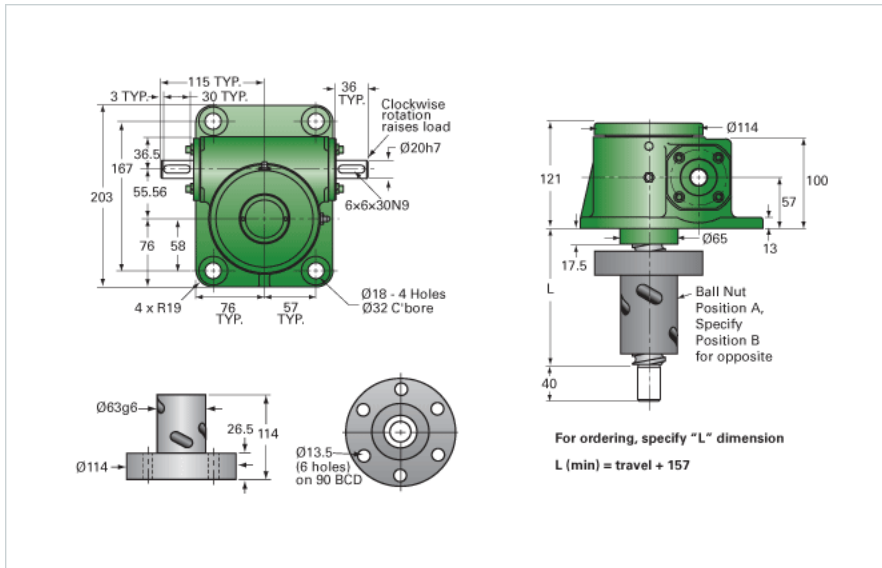

Details

Capacity [kN]	50
Gear Ratio	24:1
Travel for 1 Turn of Worm [mm]	0.42
Torque to Raise 1 kN [Nm]	0.15
No Load Torque [Nm]	1.13
Lifting Screw Diameter [mm]	40
Screw Lead [mm]	10
Root Diameter [mm]	34.8
BackDrive Holding Torque [Nm]	6.5

Performance Specifications

Maximum Allowable Input [kW]	0.56
Maximum Input Torque [Nm]	7.70
Maximum Load at 1425 RPM [kN]	24.4
Maximum Worm Speed at Rated Load [rpm]	695
Starting Torque	1.5 x Running Torque

Weight

Base 0 Travel [kg]	15.90
Per 100mm of Travel [kg]	0.93
Grease [kg]	0.45