

ActionJac EM2.5-BSJ-IR 6:1

Call 800-321-7800 or visit us online at www.nookindustries.com to configure and order your ActionJac EM2.5-BSJ-IR 6:1 today!

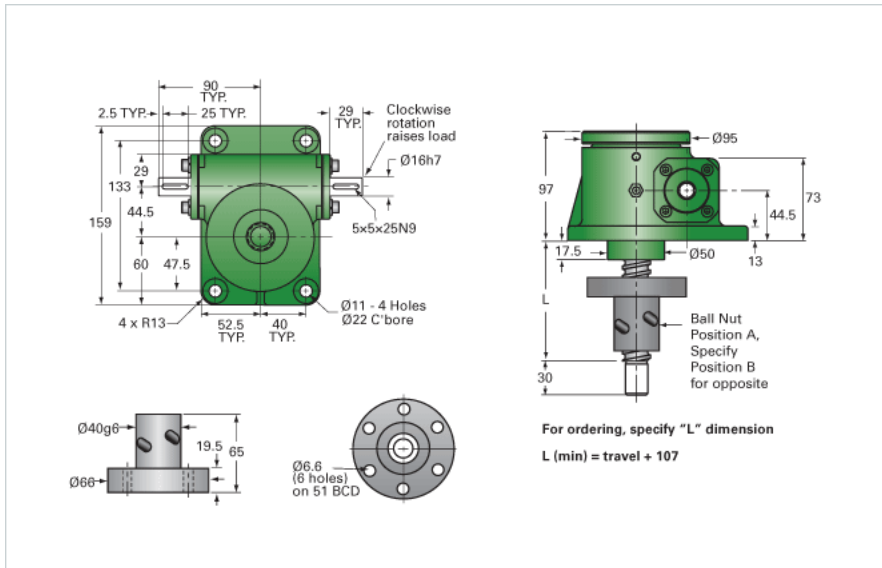

Details

Capacity [kN]	25
Gear Ratio	6:1
Travel for 1 Turn of Worm [mm]	0.83
Torque to Raise 1 kN [Nm]	0.20
No Load Torque [Nm]	0.56
Lifting Screw Diameter [mm]	25
Screw Lead [mm]	5
Root Diameter [mm]	22.5
BackDrive Holding Torque [Nm]	4.5

Performance Specifications

Maximum Allowable Input [kW]	1.08
Maximum Input Torque [Nm]	5.05
Maximum Load at 1425 RPM [kN]	25
Maximum Worm Speed at Rated Load [rpm]	2035
Starting Torque	1.5 x Running Torque

Weight

Base 0 Travel [kg]	7.70
Per 100mm of Travel [kg]	0.36
Grease [kg]	0.22