

ActionJac MJ-80-UK 20:1

Call 800-321-7800 or visit us online at www.nookindustries.com to configure and order your ActionJac MJ-80-UK 20:1 today!

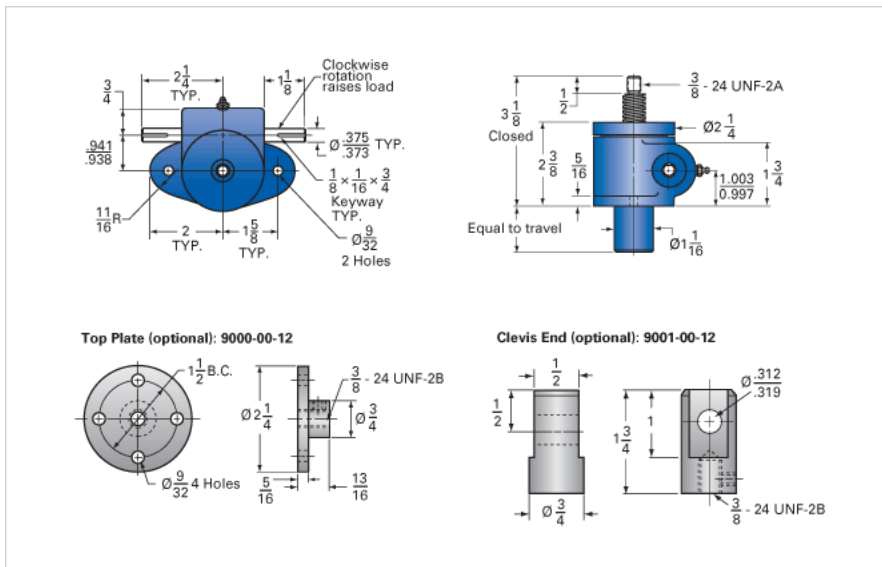

Details

Capacity [Ton]	0.5
Gear Ratio	20:1
Turns of Worm Per Inch Travel	80
Torque to Raise 1 lb. [in-lb]	0.0090
Lifting Screw Diameter [in]	0.50
Screw Lead [in]	0.250
Root Diameter [in]	0.332
Tare Drag Torque [in-lb]	-

Performance Specifications

Maximum Allowable Input [hp]	0.17
Maximum Input Torque [in-lb]	8
Compression Loading Maximum Travel at 1000 lbs. [lbs]	7.20
Compression Loading Maximum Travel at Any Load [lbs]	8.75
Maximum Worm Speed at Rated Load [rpm]	1140
Travel Rate at 1750 rpm [in/min]	22.5
Maximum Load at 1750 RPM [lb]	720
Starting Torque	2 x Running Torque

Weight

Base 0 Travel [lb]	2.5
Per Inch of Travel [lb]	0.20
Grease [lb]	0.5