

ActionJac MJ-200-IK 20:1

Call 800-321-7800 or visit us online at www.nookindustries.com to configure and order your ActionJac MJ-200-IK 20:1 today!

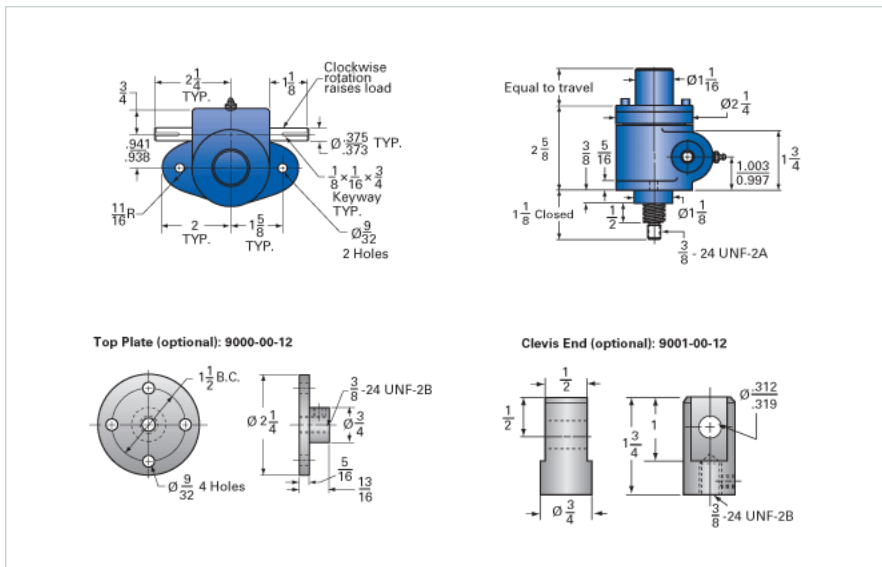

Details

| | |
|-------------------------------|--------|
| Capacity [Ton] | 0.5 |
| Gear Ratio | 20:1 |
| Turns of Worm Per Inch Travel | 200 |
| Torque to Raise 1 lb. [in-lb] | 0.0070 |
| Lifting Screw Diameter [in] | 0.50 |
| Screw Lead [in] | 0.100 |
| Root Diameter [in] | 0.359 |
| Tare Drag Torque [in-lb] | - |

Performance Specifications

| | |
|---|--------------------|
| Maximum Allowable Input [hp] | 0.17 |
| Maximum Input Torque [in-lb] | 5.7 |
| Compression Loading Maximum Travel at 1000 lbs. [lbs] | 8.30 |
| Compression Loading Maximum Travel at Any Load [lbs] | 9.38 |
| Maximum Worm Speed at Rated Load [rpm] | 1560 |
| Travel Rate at 1750 rpm [in/min] | 9 |
| Maximum Load at 1750 RPM [lb] | 1000 |
| Starting Torque | 2 x Running Torque |

Weight

| | |
|-------------------------|------|
| Base 0 Travel [lb] | 2.5 |
| Per Inch of Travel [lb] | 0.20 |
| Grease [lb] | 0.5 |