

ActionJac MJ-20-IK 5:1

Call 800-321-7800 or visit us online at www.nookindustries.com to configure and order your ActionJac MJ-20-IK 5:1 today!

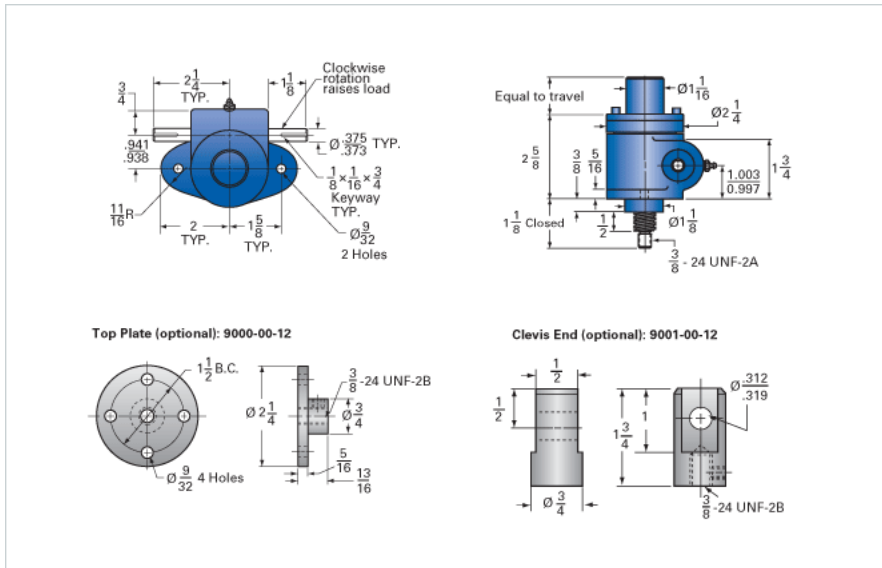

Details

Capacity [Ton]	0.5
Gear Ratio	5:1
Turns of Worm Per Inch Travel	20
Torque to Raise 1 lb. [in-lb]	0.0220
Lifting Screw Diameter [in]	0.50
Screw Lead [in]	0.250
Root Diameter [in]	0.332
Tare Drag Torque [in-lb]	-

Performance Specifications

Maximum Allowable Input [hp]	0.33
Maximum Input Torque [in-lb]	19.3
Compression Loading Maximum Travel at 1000 lbs. [lbs]	7.20
Compression Loading Maximum Travel at Any Load [lbs]	8.75
Maximum Worm Speed at Rated Load [rpm]	950
Travel Rate at 1750 rpm [in/min]	90
Maximum Load at 1750 RPM [lb]	600
Starting Torque	2 x Running Torque

Weight

Base 0 Travel [lb]	2.5
Per Inch of Travel [lb]	0.20
Grease [lb]	0.5