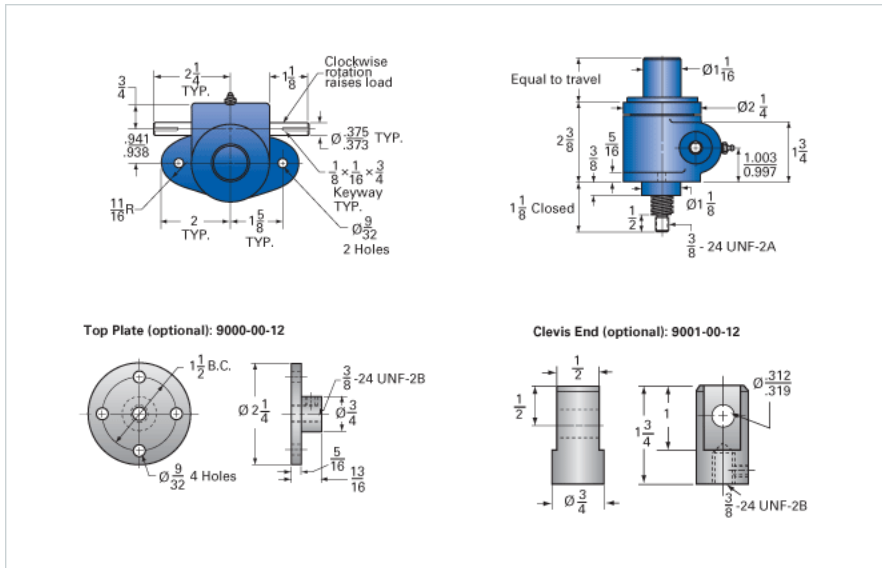

**ActionJac MJAB-25-I 5:1**

Call 800-321-7800 or visit us online at [www.nookindustries.com](http://www.nookindustries.com) to configure and order your ActionJac MJAB-25-I 5:1 today!

**Details**

Capacity [Ton]	0.5
Gear Ratio	5:1
Turns of Worm Per Inch Travel	25
Torque to Raise 1 lb. [in-lb]	0.0210
Lifting Screw Diameter [in]	0.63
Screw Lead [in]	0.200
Root Diameter [in]	0.377
Tare Drag Torque [in-lb]	-

**Performance Specifications**

Maximum Allowable Input [hp]	0.33
Maximum Input Torque [in-lb]	20.7
Compression Loading Maximum Travel at 1000 lbs. [lbs]	8.30
Compression Loading Maximum Travel at Any Load [lbs]	9.38
Maximum Worm Speed at Rated Load [rpm]	1040
Travel Rate at 1750 rpm [in/min]	72
Maximum Load at 1750 RPM [lb]	560
Starting Torque	2 x Running Torque

**Weight**

Base 0 Travel [lb]	2.5
Per Inch of Travel [lb]	0.20
Grease [lb]	0.5