

ActionJac 30-MSJ-U 10 2/3:1

Call 800-321-7800 or visit us online at www.nookindustries.com to configure and order your ActionJac 30-MSJ-U 10 2/3:1 today!

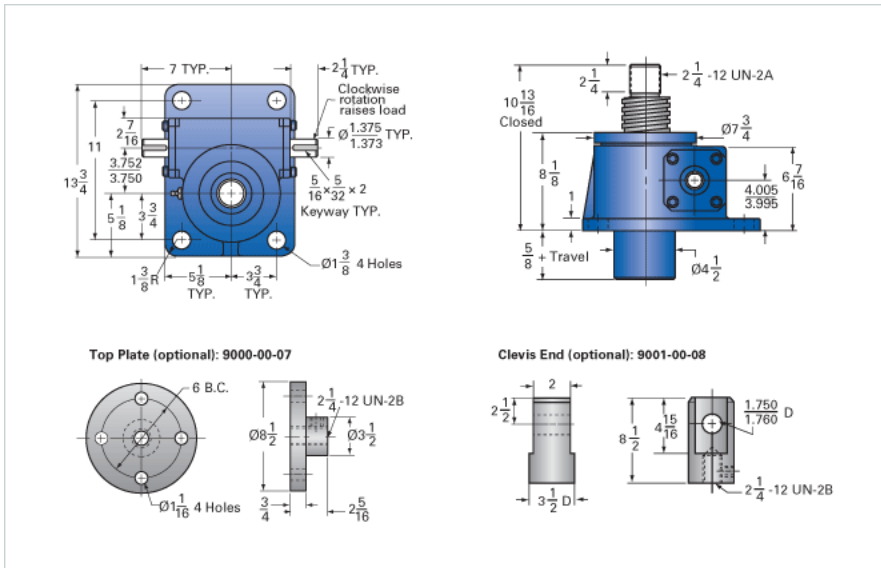

Details

Capacity [Ton]	30
Gear Ratio	10 2/3:1
Turns of Worm per Inch Travel	16
Torque to Raise 1 lb. [in-lb]	0.0452
Lifting Screw Diameter [in]	3.38
Screw Lead [in]	0.667
Root Diameter [in]	2.652
Tare Drag Torque [in-lb]	50

Performance Specifications

Maximum Allowable Input [hp]	11.00
Maximum Input Torque [in-lb]	2710
Maximum Worm Speed at Rated Load [rpm]	256
Maximum Load at 1750 RPM [lb]	8764
Starting Torque	2 x Running Torque

Weight

Base 0 Travel [lb]	145
Per Inch of Travel [lb]	2.90
Grease [lb]	1.5