

ActionJac 35-MSJ-UR 32:1

Call 800-321-7800 or visit us online at www.nookindustries.com to configure and order your ActionJac 35-MSJ-UR 32:1 today!

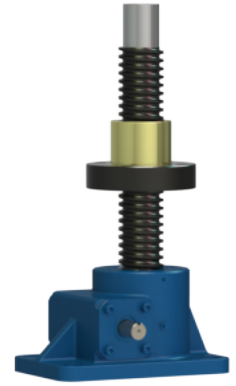
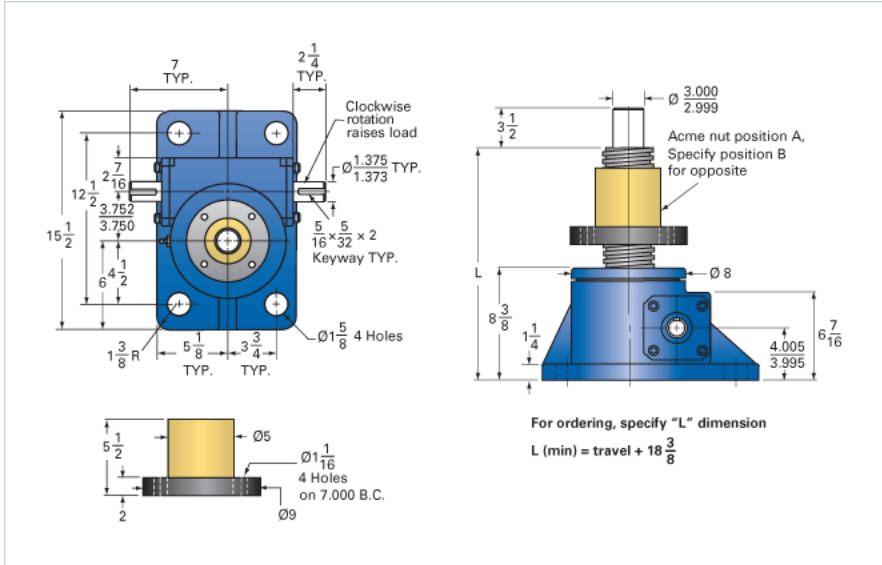

Details

Capacity [Ton]	35
Gear Ratio	32:1
Turns of Worm per Inch Travel	48
Torque to Raise 1 lb. [in-lb]	0.0257
Lifting Screw Diameter [in]	3.75
Screw Lead [in]	0.667
Root Diameter [in]	3.009
Tare Drag Torque [in-lb]	50

Performance Specifications

Maximum Allowable Input [hp]	3.50
Maximum Input Torque [in-lb]	1800
Maximum Worm Speed at Rated Load [rpm]	122
Maximum Load at 1750 RPM [lb]	4904