

ActionJac 35-MSJ-UK 10 2/3:1

Call 800-321-7800 or visit us online at www.nookindustries.com to configure and order your ActionJac 35-MSJ-UK 10 2/3:1 today!

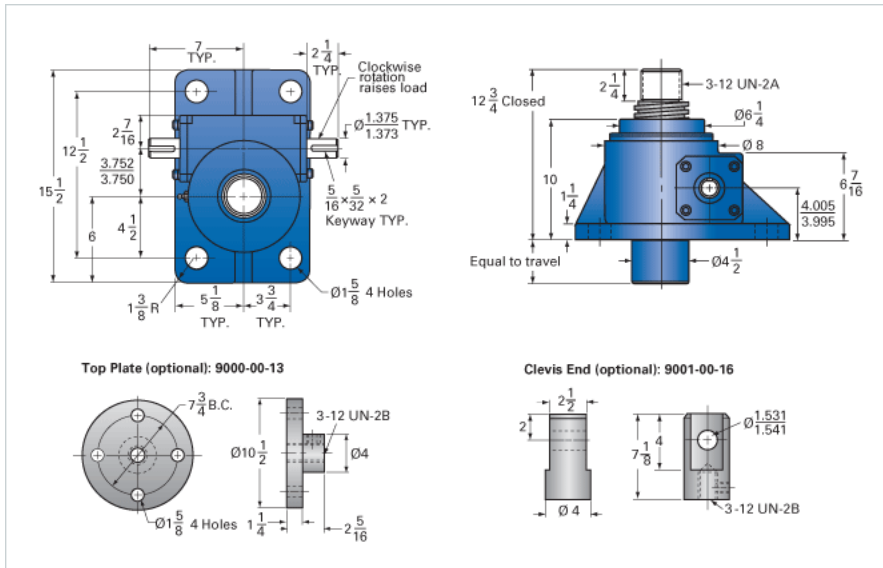

Details

| | |
|-------------------------------|----------|
| Capacity [Ton] | 35 |
| Gear Ratio | 10 2/3:1 |
| Turns of Worm per Inch Travel | 16 |
| Torque to Raise 1 lb. [in-lb] | 0.0570 |
| Lifting Screw Diameter [in] | 3.75 |
| Screw Lead [in] | 0.667 |
| Root Diameter [in] | 3.009 |
| Tare Drag Torque [in-lb] | 50 |

Performance Specifications

| | |
|--|--------------------|
| Maximum Allowable Input [hp] | 11.00 |
| Maximum Input Torque [in-lb] | 3450 |
| Maximum Worm Speed at Rated Load [rpm] | 174 |
| Maximum Load at 1750 RPM [lb] | 6950 |
| Starting Torque | 2 x Running Torque |

Weight

| | |
|-------------------------|------|
| Base 0 Travel [lb] | 145 |
| Per Inch of Travel [lb] | 3.40 |
| Grease [lb] | 3.5 |