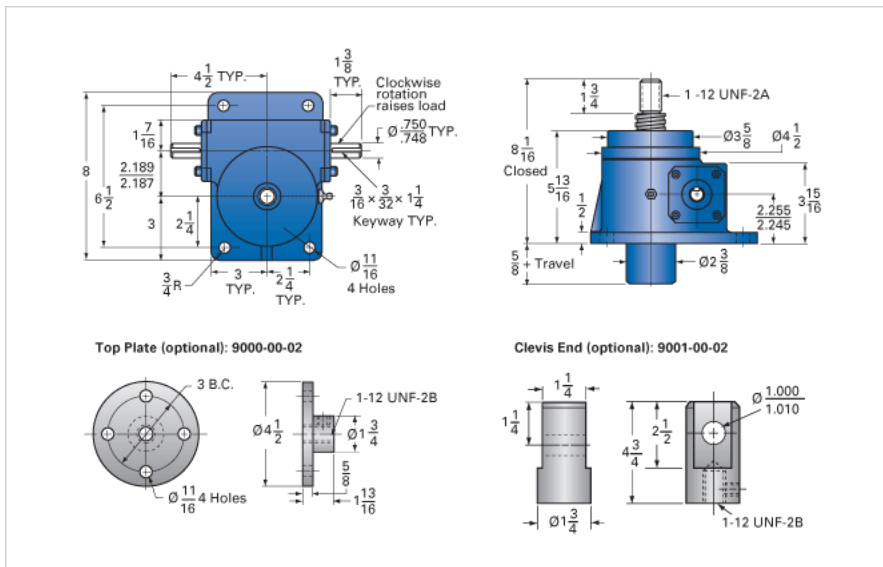

ActionJac 5-MSJ-UK 6:1

Call 800-321-7800 or visit us online at www.nookindustries.com to configure and order your ActionJac 5-MSJ-UK 6:1 today!

Details

| | |
|-------------------------------|--------|
| Capacity [Ton] | 5 |
| Gear Ratio | 6:1 |
| Turns of Worm per Inch Travel | 16 |
| Torque to Raise 1 lb. [in-lb] | 0.0432 |
| Lifting Screw Diameter [in] | 1.50 |
| Screw Lead [in] | 0.375 |
| Root Diameter [in] | 1.066 |
| Tare Drag Torque [in-lb] | 10 |

Performance Specifications

| | |
|--|--------------------|
| Maximum Allowable Input [hp] | 3.00 |
| Maximum Input Torque [in-lb] | 376 |
| Maximum Worm Speed at Rated Load [rpm] | 437 |
| Maximum Load at 1750 RPM [lb] | 2501 |
| Starting Torque | 2 x Running Torque |

Weight

| | |
|-------------------------|------|
| Base 0 Travel [lb] | 30 |
| Per Inch of Travel [lb] | 0.70 |
| Grease [lb] | 1.0 |