

## ActionJac 10AB-MSJ-U 24:1

Call 800-321-7800 or visit us online at [www.nookindustries.com](http://www.nookindustries.com) to configure and order your ActionJac 10AB-MSJ-U 24:1 today!

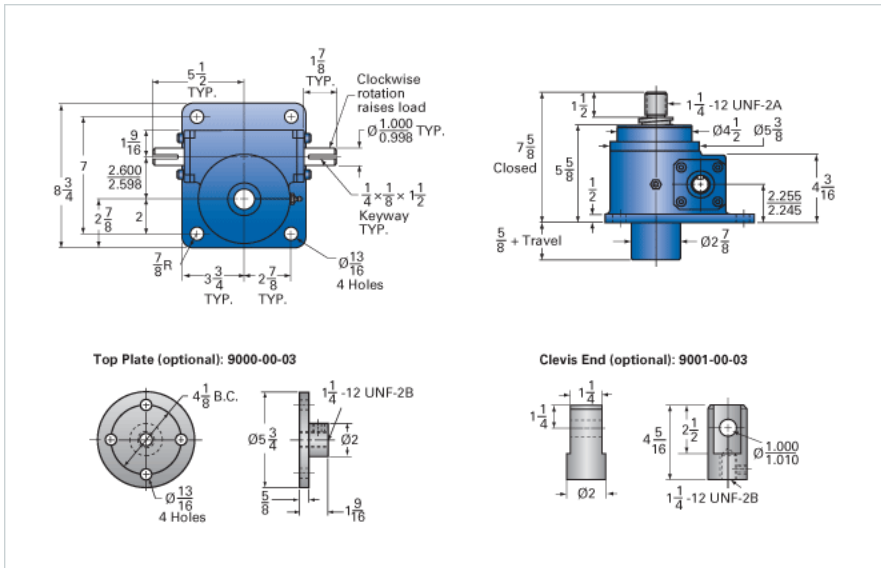

### Details

|                               |        |
|-------------------------------|--------|
| Capacity [Ton]                | 10     |
| Gear Ratio                    | 24:1   |
| Turns of Worm per Inch Travel | 48     |
| Torque to Raise 1 lb. [in-lb] | 0.0192 |
| Lifting Screw Diameter [in]   | 2.00   |
| Screw Lead [in]               | 0.500  |
| Root Diameter [in]            | 1.410  |
| Tare Drag Torque [in-lb]      | 20     |

### Performance Specifications

|  |                    |
|--|--------------------|
| Maximum Allowable Input [hp]           | 1.50               |
| Maximum Input Torque [in-lb]           | 384                |
| Maximum Worm Speed at Rated Load [rpm] | 246                |
| Maximum Load at 1750 RPM [lb]          | 2813               |
| Starting Torque                        | 2 x Running Torque |

### Weight

|                         |      |
|-------------------------|------|
| Base 0 Travel [lb]      | 45   |
| Per Inch of Travel [lb] | 1.20 |
| Grease [lb]             | 1.5  |