

ActionJac 1-MSJ-I 5:1

Call 800-321-7800 or visit us online at www.nookindustries.com to configure and order your ActionJac 1-MSJ-I 5:1 today!

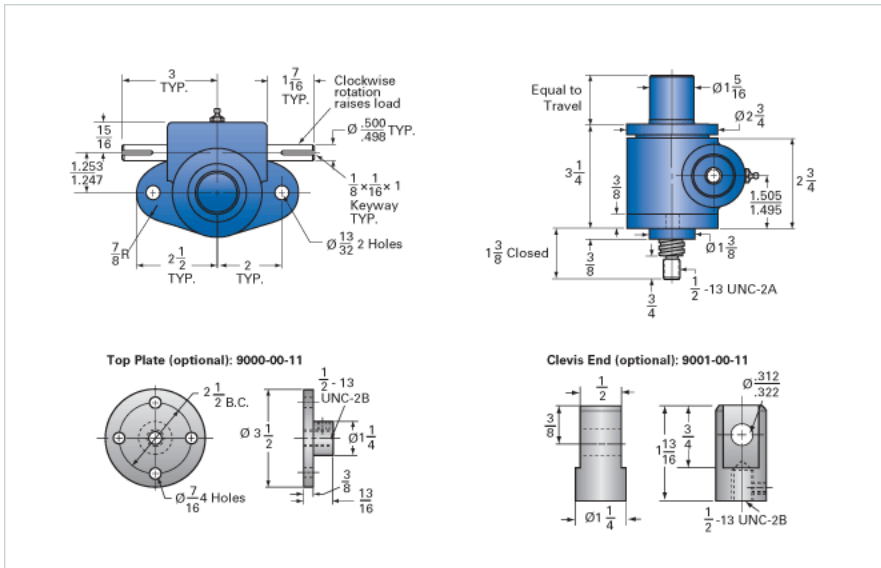

Details

Capacity [Ton]	1
Gear Ratio	5:1
Turns of Worm per Inch Travel	25
Torque to Raise 1 lb. [in-lb]	0.0225
Lifting Screw Diameter [in]	0.75
Screw Lead [in]	0.200
Root Diameter [in]	0.502
Tare Drag Torque [in-lb]	3

Performance Specifications

Maximum Allowable Input [hp]	0.50
Maximum Input Torque [in-lb]	45
Maximum Worm Speed at Rated Load [rpm]	700
Maximum Load at 1750 RPM [lb]	800
Starting Torque	2 x Running Torque

Weight

Base 0 Travel [lb]	5.5
Per Inch of Travel [lb]	0.30
Grease [lb]	0.5