

## ActionJac 35-MSJ-IR 10 2/3:1

Call 800-321-7800 or visit us online at [www.nookindustries.com](http://www.nookindustries.com) to configure and order your ActionJac 35-MSJ-IR 10 2/3:1 today!

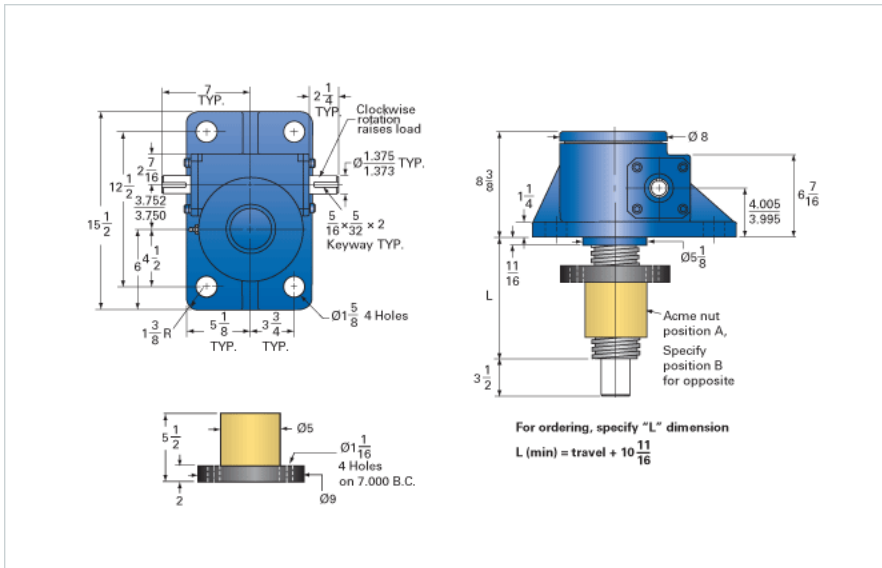
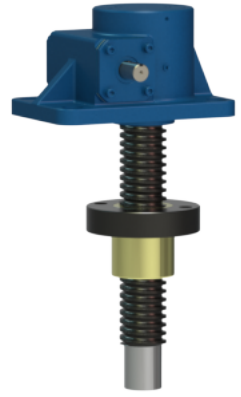

### Details

Capacity [Ton]	35
Gear Ratio	10 2/3:1
Turns of Worm per Inch Travel	16
Torque to Raise 1 lb. [in-lb]	0.0493
Lifting Screw Diameter [in]	3.75
Screw Lead [in]	0.667
Root Diameter [in]	3.009
Tare Drag Torque [in-lb]	50

### Performance Specifications

Maximum Allowable Input [hp]	11.00
Maximum Input Torque [in-lb]	3450
Maximum Worm Speed at Rated Load [rpm]	200
Maximum Load at 1750 RPM [lb]	8035
Starting Torque	2 x Running Torque

### Weight

Base 0 Travel [lb]	145
Per Inch of Travel [lb]	3.40
Grease [lb]	3.5