

## ActionJac 2-MSJ-IK 12:1

Call 800-321-7800 or visit us online at [www.nookindustries.com](http://www.nookindustries.com) to configure and order your ActionJac 2-MSJ-IK 12:1 today!

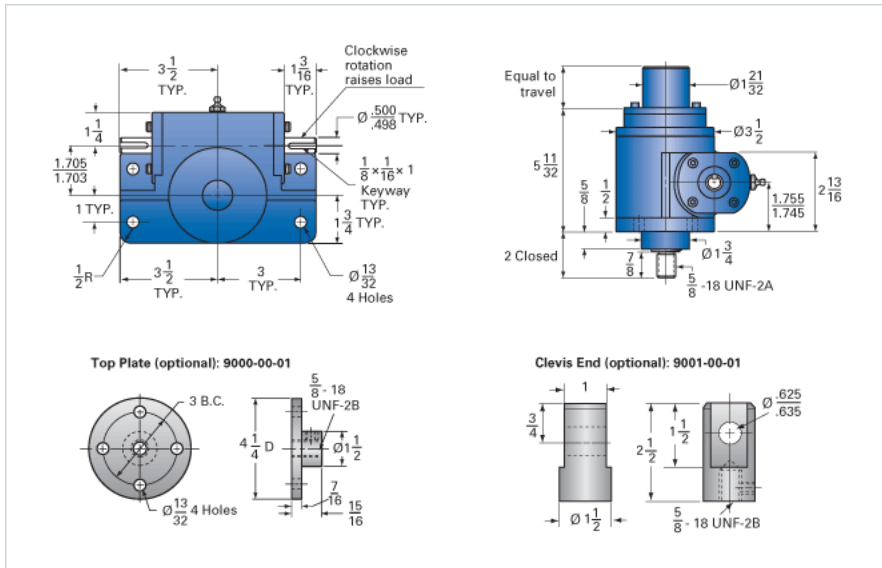

### Details

Capacity [Ton]	2
Gear Ratio	12:1
Turns of Worm per Inch Travel	48
Torque to Raise 1 lb. [in-lb]	0.0177
Lifting Screw Diameter [in]	1.00
Screw Lead [in]	0.250
Root Diameter [in]	0.698
Tare Drag Torque [in-lb]	4

### Performance Specifications

Maximum Allowable Input [hp]	1.50
Maximum Input Torque [in-lb]	62
Maximum Worm Speed at Rated Load [rpm]	1326
Maximum Load at 1750 RPM [lb]	3031
Starting Torque	2 x Running Torque

### Weight

Base 0 Travel [lb]	15
Per Inch of Travel [lb]	0.45
Grease [lb]	0.5