

## ActionJac 10AB-MSJ-I 24:1

Call 800-321-7800 or visit us online at [www.nookindustries.com](http://www.nookindustries.com) to configure and order your ActionJac 10AB-MSJ-I 24:1 today!

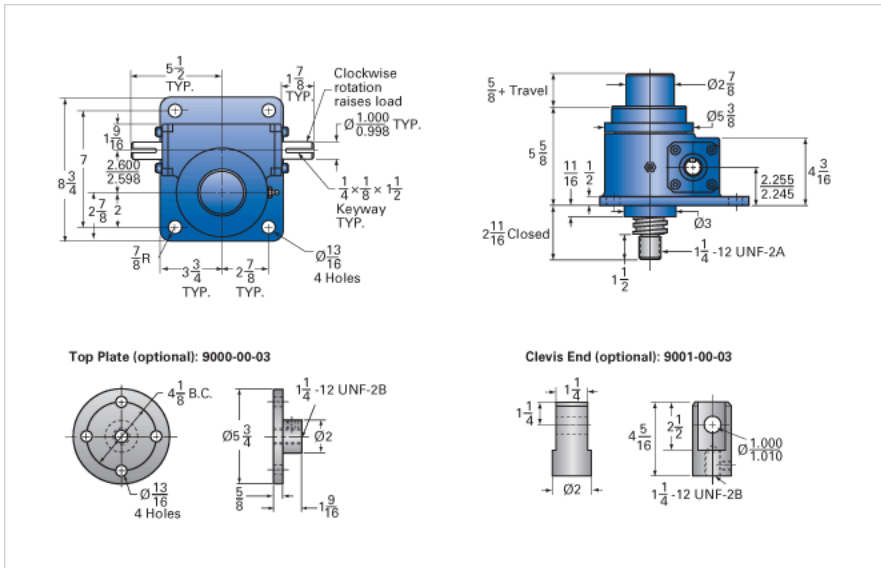

### Details

Capacity [Ton]	10
Gear Ratio	24:1
Turns of Worm per Inch Travel	48
Torque to Raise 1 lb. [in-lb]	0.0192
Lifting Screw Diameter [in]	2.00
Screw Lead [in]	0.500
Root Diameter [in]	1.410
Tare Drag Torque [in-lb]	20

### Performance Specifications

Maximum Allowable Input [hp]	1.50
Maximum Input Torque [in-lb]	384
Maximum Worm Speed at Rated Load [rpm]	246
Maximum Load at 1750 RPM [lb]	2813
Starting Torque	2 x Running Torque

### Weight

Base 0 Travel [lb]	45
Per Inch of Travel [lb]	1.20
Grease [lb]	1.5