

ActionJac 5HL-BSJ-U 6:1

Call 800-321-7800 or visit us online at www.nookindustries.com to configure and order your ActionJac 5HL-BSJ-U 6:1 today!

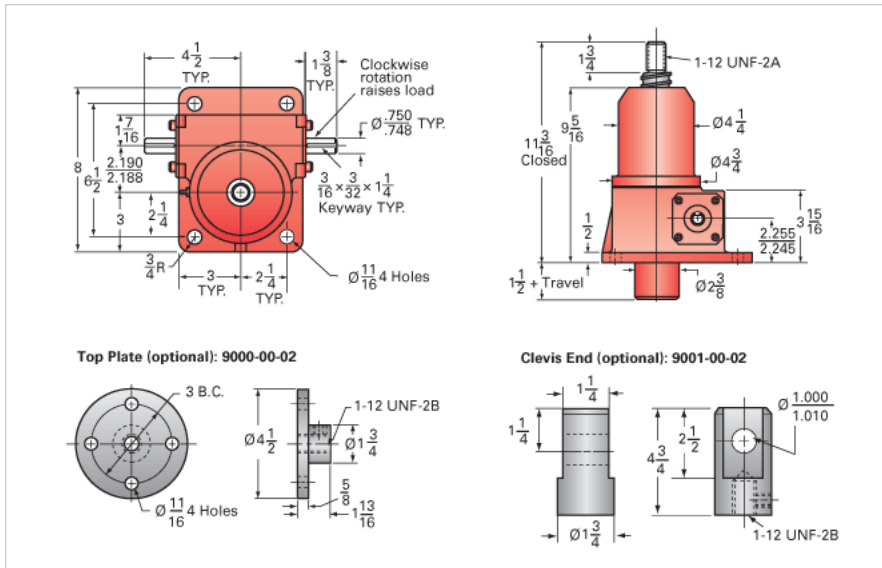

Details

Capacity [Ton]	5
Gear Ratio	6:1
Turns of Worm per Inch Travel	6
Torque to Raise 1 lb. [in-lb]	0.0387
Lifting Screw Diameter [in]	1.50
Screw Lead [in]	1.000
Root Diameter [in]	1.140
BackDrive Holding Torque [ft-lb]	30
Tare Drag Torque [in-lb]	10

Performance Specifications

Maximum Allowable Input [hp]	3.00
Maximum Input Torque [in-lb]	387
Maximum Worm Speed at Rated Load [rpm]	488
Maximum Load at 1750 RPM [lb]	2792
Starting Torque	1.5 x Running Torque

Weight

Base 0 Travel [lb]	35
Per Inch of Travel [lb]	0.60
Grease [lb]	1.0