

## ActionJac 100-BSJ-UR 10 2/3:1

Call 800-321-7800 or visit us online at [www.nookindustries.com](http://www.nookindustries.com) to configure and order your ActionJac 100-BSJ-UR 10 2/3:1 today!

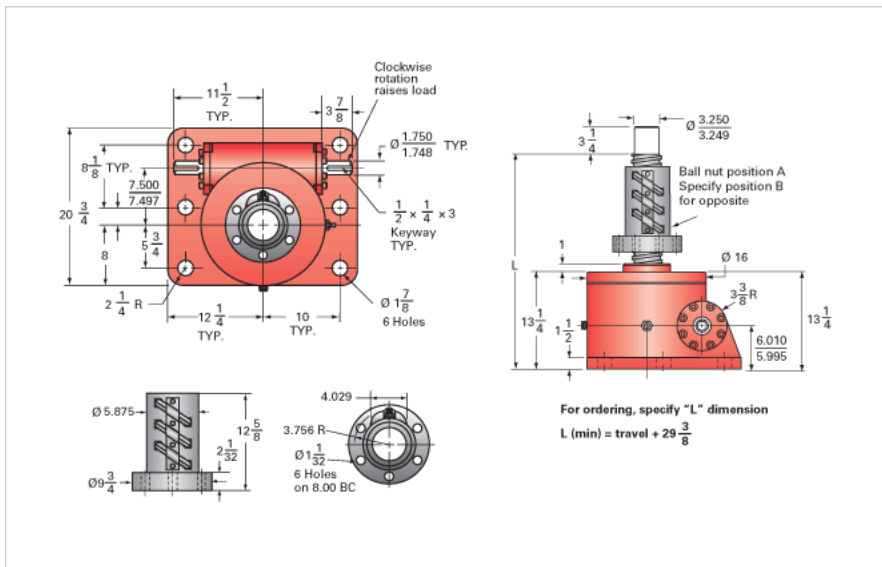

### Details

Capacity [Ton]	100
Gear Ratio	10 2/3:1
Turns of Worm per Inch Travel	10.66
Torque to Raise 1 lb. [in-lb]	0.0244
Lifting Screw Diameter [in]	4.00
Screw Lead [in]	1.000
Root Diameter [in]	3.338
BackDrive Holding Torque [ft-lb]	152
Tare Drag Torque [in-lb]	205

### Performance Specifications

Maximum Allowable Input [hp]	32.00
Maximum Input Torque [in-lb]	4880
Maximum Worm Speed at Rated Load [rpm]	413
Maximum Load at 1750 RPM [lb]	47232
Starting Torque	1.5 x Running Torque

### Weight

Base 0 Travel [lb]	1100
Per Inch of Travel [lb]	5.00
Grease [lb]	16.0