

## ActionJac 20HL-BSJ-UK 8:1

Call 800-321-7800 or visit us online at [www.nookindustries.com](http://www.nookindustries.com) to configure and order your ActionJac 20HL-BSJ-UK 8:1 today!

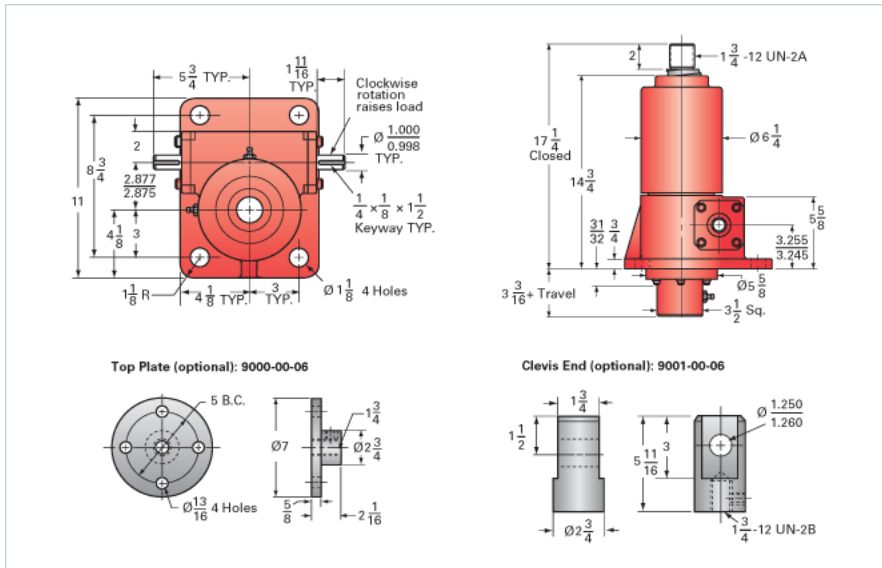

### Details

Capacity [Ton]	20
Gear Ratio	8:1
Turns of Worm per Inch Travel	8
Torque to Raise 1 lb. [in-lb]	0.0344
Lifting Screw Diameter [in]	2.25
Screw Lead [in]	1.000
Root Diameter [in]	1.850
BackDrive Holding Torque [ft-lb]	54
Tare Drag Torque [in-lb]	40

### Performance Specifications

Maximum Allowable Input [hp]	7.50
Maximum Input Torque [in-lb]	1253
Maximum Worm Speed at Rated Load [rpm]	343
Maximum Load at 1750 RPM [lb]	7840
Starting Torque	1.5 x Running Torque

### Weight

Base 0 Travel [lb]	85
Per Inch of Travel [lb]	1.50
Grease [lb]	2.2