

ActionJac 10-BSJ-UK 8:1

Call 800-321-7800 or visit us online at www.nookindustries.com to configure and order your ActionJac 10-BSJ-UK 8:1 today!

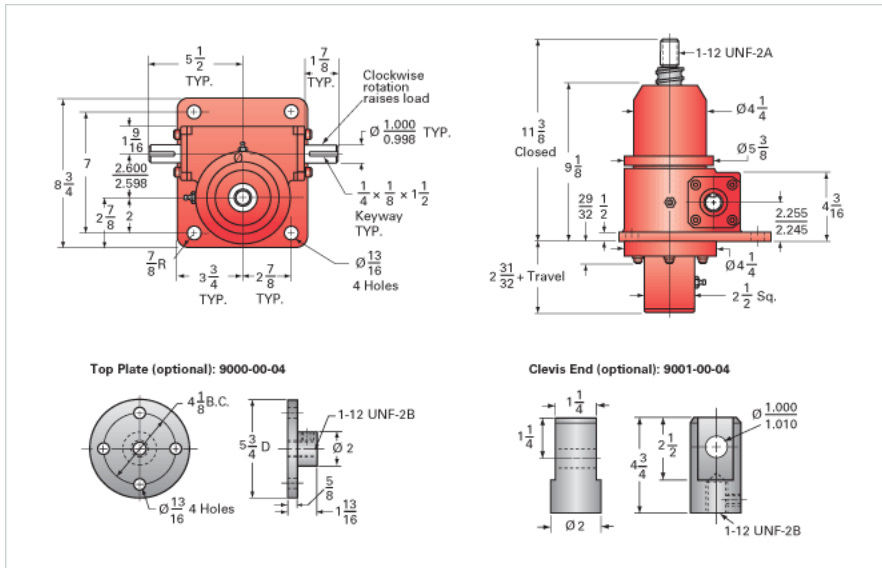

Details

Capacity [Ton]	10
Gear Ratio	8:1
Turns of Worm per Inch Travel	16.88
Torque to Raise 1 lb. [in-lb]	0.0166
Lifting Screw Diameter [in]	1.50
Screw Lead [in]	0.473
Root Diameter [in]	1.140
BackDrive Holding Torque [ft-lb]	13
Tare Drag Torque [in-lb]	20

Performance Specifications

Maximum Allowable Input [hp]	5.00
Maximum Input Torque [in-lb]	302
Maximum Worm Speed at Rated Load [rpm]	949
Maximum Load at 1750 RPM [lb]	10847
Starting Torque	1.5 x Running Torque

Weight

Base 0 Travel [lb]	50
Per Inch of Travel [lb]	0.80
Grease [lb]	1.5