

ActionJac 1HL-BSJ-I 20:1

Call 800-321-7800 or visit us online at www.nookindustries.com to configure and order your ActionJac 1HL-BSJ-I 20:1 today!

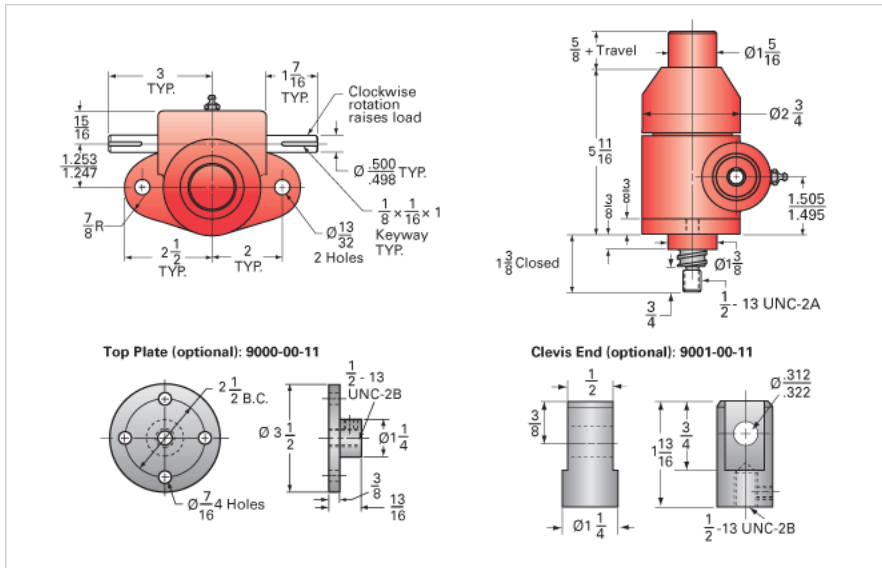

Details

Capacity [Ton]	1
Gear Ratio	20:1
Turns of Worm per Inch Travel	40
Torque to Raise 1 lb. [in-lb]	0.0114
Lifting Screw Diameter [in]	0.75
Screw Lead [in]	0.500
Root Diameter [in]	0.602
BackDrive Holding Torque [ft-lb]	1.5
Tare Drag Torque [in-lb]	3

Performance Specifications

Maximum Allowable Input [hp]	0.25
Maximum Input Torque [in-lb]	9
Maximum Worm Speed at Rated Load [rpm]	691
Maximum Load at 1750 RPM [lb]	790
Starting Torque	1.5 x Running Torque

Weight

Base 0 Travel [lb]	8
Per Inch of Travel [lb]	0.04
Grease [lb]	0.5