

ActionJac 0.5HL-BSJ-I 5:1

Call 800-321-7800 or visit us online at www.nookindustries.com to configure and order your ActionJac 0.5HL-BSJ-I 5:1 today!

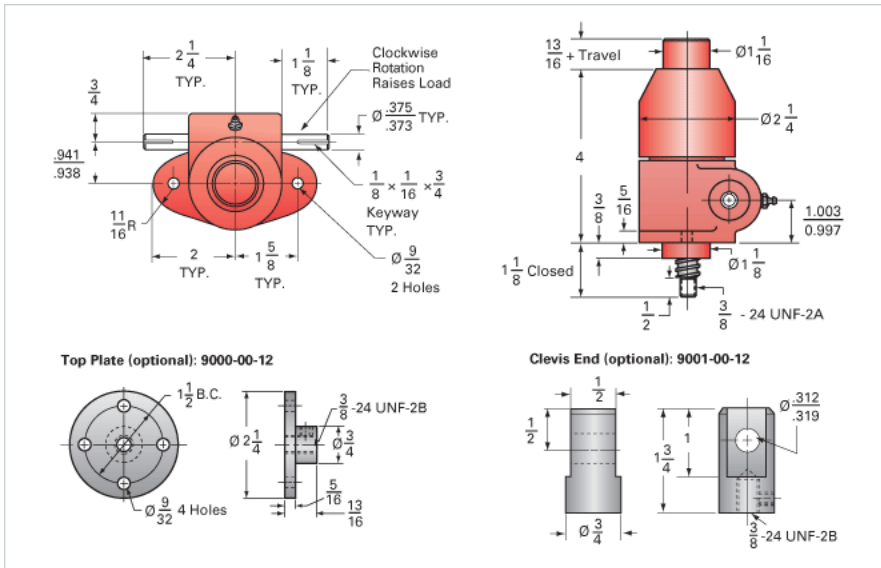

Details

Capacity [Ton]	0.5
Gear Ratio	5:1
Turns of Worm per Inch Travel	10
Torque to Raise 1 lb. [in-lb]	0.0242
Lifting Screw Diameter [in]	0.63
Screw Lead [in]	0.500
Root Diameter [in]	0.500
BackDrive Holding Torque [ft-lb]	2.0
Tare Drag Torque [in-lb]	1

Performance Specifications

Maximum Allowable Input [hp]	0.33
Maximum Input Torque [in-lb]	24.2
Maximum Worm Speed at Rated Load [rpm]	868
Maximum Load at 1750 RPM [lb]	496
Starting Torque	1.5 x Running Torque

Weight

Base 0 Travel [lb]	3
Per Inch of Travel [lb]	0.03
Grease [lb]	0.6