

## ActionJac 30-BSJ-IR 10 2/3:1

Call 800-321-7800 or visit us online at [www.nookindustries.com](http://www.nookindustries.com) to configure and order your ActionJac 30-BSJ-IR 10 2/3:1 today!

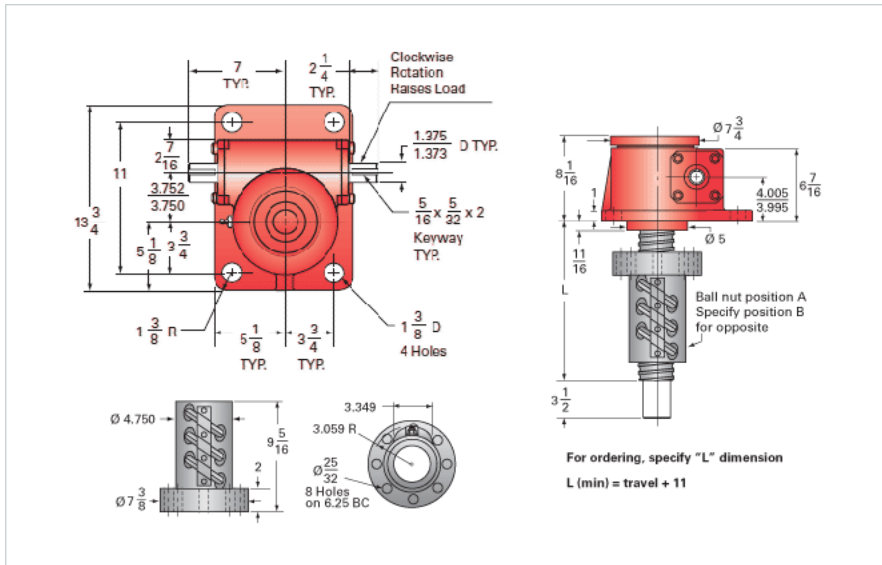

### Details

Capacity [Ton]	30
Gear Ratio	10 2/3:1
Turns of Worm per Inch Travel	16.16
Torque to Raise 1 lb. [in-lb]	0.0162
Lifting Screw Diameter [in]	3.00
Screw Lead [in]	0.660
Root Diameter [in]	2.480
BackDrive Holding Torque [ft-lb]	21.0
Tare Drag Torque [in-lb]	60

### Performance Specifications

Maximum Allowable Input [hp]	11.00
Maximum Input Torque [in-lb]	969
Maximum Worm Speed at Rated Load [rpm]	715
Maximum Load at 1750 RPM [lb]	24515
Starting Torque	1.5 x Running Torque

### Weight

Base 0 Travel [lb]	220
Per Inch of Travel [lb]	2.40
Grease [lb]	3.5